



Metasol

Meta Solution

For Nuclear power plant
Contactors and Overload relays



Contactors and Overload Relays

New generation of Contactors from LSIS



Metasol Contactors

Metasol
Contactors
For Nuclear power plant



LSIS META SOLUTION CONTACTORS

Contents :

Table of specifications	8
Type numbering system	12
Environment	13
Marking	14
Internal structure	15
Contactors	16
Contactor relays	34
Accessory	35
Overload relays	38
Overload relay specifications	40
Overload relay operation	44
Accessories for overload relay	45
Overload relay ordering types	48
Overload relay trip curves	54
Dimension	62



■ Designed to show superior technology: The Metasol series

Sealed structure has improved its safety features so that no arc flash is exposed. In order to emphasize its durability as an industrial device, Metasol series adopt simple design form and sophisticated shape applying diamond cut concepts on product surface.



Series completion

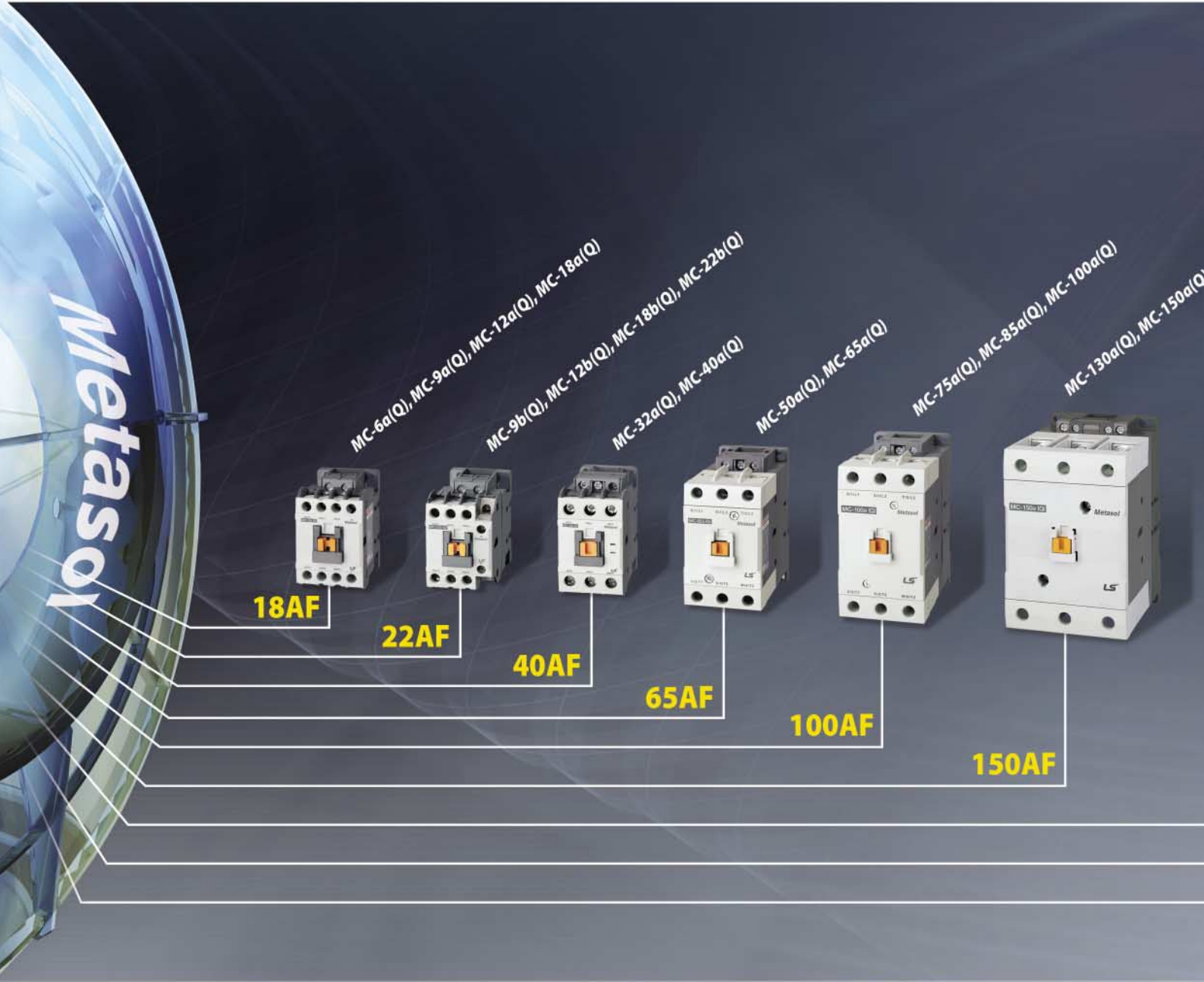

More Safe,
More Valuable



Contactors & Overload Relays



- *Advanced technology & Expert solution*
- *Offering economical solution with compact size & easy connection*
- *Ensure reliability in the system: Type II Coordination*
- *Perfect system with peripheral devices.*
- *Environment friendly product: complies with International environment standard RoHS.*
- *25 Models in 9 Frames*



MC/TOR Accessories

Perfect combination of peripheral devices and various accessories

Offering economical solution with compact size & easy connection



Perfect system with other devices and accessories

■ One-touch connection

- Din Rail connection without any special tools
- Direct combine a surge unit

■ Simple wiring

- Mounting unit, Adapter
- Reversing wire set

■ Easy Maintenance

- 4-terminal type: Easy wiring of operation coil
- Module type of Screw terminal
- Interlock unit with built-in auxiliary contacts(2NO built-in)

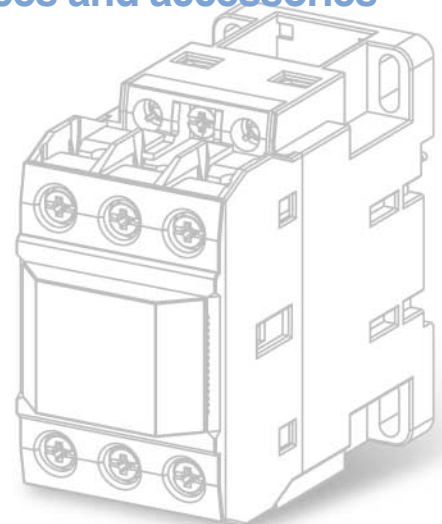

Advanced accessories for Metasol contactors

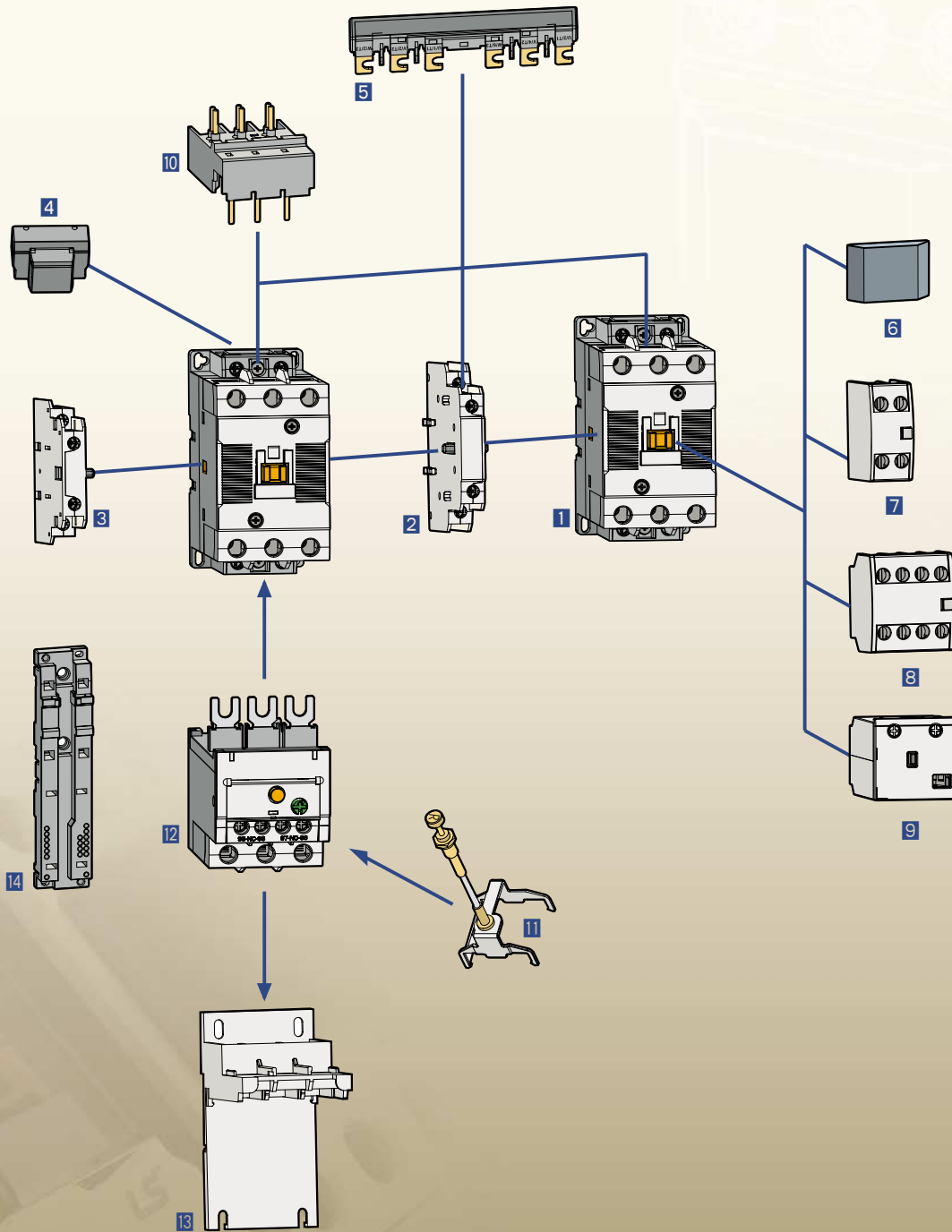

- | | | |
|---|--|--|
| 1 Contactor | 6 Safety cover (Option) | 10 Direct adaptor to MMS |
| 2 Interlock unit | 7 Auxiliary contact unit
- front mount(2p) | 11 Remote reset unit |
| 3 Auxiliary contact unit
- side mount | 8 Auxiliary contact unit
- front mount(4p) | 12 Overload relay |
| 4 Surge unit | 9 Mechanical latch unit | 13 Separate mounting unit |
| 5 Wire kit | | 14 Mounting unit for use with MMS |

MC type Magnetic Contactors



Frame size			
Type	screws clamp terminals		
Number of poles			
Rated operational voltage, Ue			
Rated insulation voltage, Ui			
Rated frequency			
Rated impulse withstand voltage, Uimp			
Maximum operating rate in operating cycles per hour(AC3)			
Durability	Mechanical		
	Electrical		
Current and power	AC-1, Thermal current	A	
	AC-3	200/240V	kW
		380/440V	kW
	500/550V	A	
		kW	
	690V	kW	
UL rating (50/60Hz)	Continuous current		
	Single phase	110~120V	HP
		220~240V	HP
		200~208V	HP
	Three phase	220~240V	HP
		440~480V	HP
		550~600V	HP
NEMA size			
Size and weight	AC control	Weight	kg
		Size(W × H × D)	mm
	DC control	Weight	kg
		Size(W × H × D)	mm



Note) Minimum conduct current of Auxiliary contactor is DC 17V 5mA.

MT type Thermal Overload Relays



Type	Screws clamp terminals		
Rated operational voltage, Ue			
Rated insulation voltage, Ui			
Rated impulse withstand voltage, Uimp			
Trip class			
Setting range			
Size and weight		Weight	kg
		Size(W × H × D)	mm

* The safety cover of magnetic contactor and thermal overload relay is optional.

18AF				
MC-6a(Q)	MC-9a(Q)	MC-12a(Q)	MC-18a(Q)	
●	●	●	●	
3pole				
690V				
690V				
50/60Hz				
6kV				
1800 operations per hour				
15 mil. operations				
2.5 mil. operations				
25	25	25	32	
2.2	2.5	3.5	4.5	
9	11	13	18	
3	4	5.5	7.5	
7	9	12	18	
3	4	7.5	7.5	
6	7	12	13	
3	4	7.5	7.5	
4	5	9	9	
25	25	25	32	
0.5	0.5	0.75	1	
1.5	1.5	2	3	
2	2	3	5	
3	3	5	7.5	
5	5	7.5	10	
7.5	7.5	10	15	
00	00	0	1	
0.33				
45 × 73.5 × 80.4				
0.4				
45 × 73.5 × 96.6				
1NO or 1NC				
UA-1				
UA-2, UA-4				



22AF

MC-9b(Q)	MC-12b(Q)	MC-18b(Q)	MC-22b(Q)
●	●	●	●
3pole			
690V			
690V			
50/60Hz			
6kV			
1800 operations per hour			
15 mil. operations			
2.5 mil. operations			
25	25	40	40
2.5	3.5	4.5	5.5
11	13	18	22
4	5.5	7.5	11
9	12	18	22
4	7.5	7.5	15
7	12	13	20
4	7.5	7.5	15
6	9	9	18
25	25	40	40
0.5	0.75	1	2
1.5	2	3	3
2	3	5	7.5
3	5	7.5	10
5	7.5	10	15
7.5	10	15	20
00	00	1	
0.34			
45 × 73.5 × 87.4			
0.41			
45 × 73.5 × 103.6			

1NO1NC

UA-1
UA-2, UA-4



40AF

MC-32a(Q)	MC-40a(Q)
●	●
3pole	
690V	
1000V	
50/60Hz	
8kV	
1800 operations per hour	
12 mil. operations	
2 mil. operations	
50	60
7.5	11
32	40
15	18.5
32	40
18.5	22
28	32
18.5	22
20	23
50	60
2	3
5	7.5
7.5	15
10	15
20	30
25	30
1P	2
0.4	
45 × 83 × 90	
0.6	
45 × 83 × 117.1	

2NO2NC

UA-1
UA-2, UA-4



65AF

MC-50a(Q)	MC-65a(Q)
●	●
3pole	
690V	
1000V	
50/60Hz	
8kV	
1800 operations per hour	
12 mil. operations	
2 mil. operations	
70	100
15	18.5
55	65
22	30
50	65
30	33
43	60
30	33
28	35
70	100
3	5
10	15
20	25
25	30
40	50
50	60
0.9	
55 × 106 × 119	
1.2	
55 × 106 × 146.4	

2NO2NC

UA-1
UA-2, UA-4



MT-32/□(Q)

●
690V
690V
6kV
10A, 20
0.1-40A
0.17
45 × 75 × 90



MT-32/□(Q)

●
690V
690V
6kV
10A, 20
0.1-40A
0.17
45 × 75 × 90



MT-63/□(Q)

●
690V
690V
6kV
10A, 20
4-65A
0.31/0.33
55 × 81 × 100

MC type Magnetic Contactors



Frame size			
Type	screws clamp terminals		
Number of poles			
Rated operational voltage, Ue			
Rated insulation voltage, Ui			
Rated frequency			
Rated impulse withstand voltage, Uimp			
Maximum operating rate in operating cycles per hour(AC3)			
Durability	Mechanical		
	Electrical		
Current and power	AC-1, Thermal current	A	
	AC-3	200/240V	kW
			A
		380/440V	kW
			A
		500/550V	kW
			A
		690V	kW
UL rating (50/60Hz)	Continuous current	A	
		Single phase	110~120V HP
			220~240V HP
	Three phase		200~208V HP
			220~240V HP
			440~480V HP
		550~600V HP	
	Size and weight	NEMA size	AC control
DC control			Weight kg Size(W × H × D) mm
Auxiliary(standard)			
Auxiliary	Side mount		
	Front mount		



Note) Minimum conduct current of Auxiliary contactor is DC 17V 5mA.

MT type Thermal Overload Relays



Type	Screws clamp terminals		
Rated operational voltage, Ue			
Rated insulation voltage, Ui			
Rated impulse withstand voltage, Uimp			
Trip class			
Setting range			
Size and weight	Weight	kg	
		Size(W × H × D)	mm



* The safety cover of magnetic contactor and thermal overload relay is optional.

150AF			
	MC-100a(Q)	MC-130a(Q)	MC-150a(Q)
		●	●
		3pole	
		690V	
		1000V	
		50/60Hz	
		8kV	
		1200 operations per hour	
		5 mil. operations	
		1 mil. operations	
	160	160	210
	30	37	45
	105	130	150
	55	60	75
	105	130	150
	55	60	70
	85	90	100
	55	55	55
	65	60	60
	160	160	210
	10	10	15
	20	20	25
	30	40	40
	40	40	50
	75	75	100
	75	75	75
			3, 4
		2.4	
		95 × 158 × 130.3	
UA-1			
UA-2, UA-4			



225AF

MC-185a(Q)	MC-225a(Q)
●	●
3pole	
690V	
1000V	
50/60Hz	
8kV	
1200 operations per hour	
5 mil. operations	
1 mil. operations	
230	275
55	75
185	225
90	132
185	225
110	132
180	200
110	140
120	150
230	275
15	15
30	40
60	60
60	75
125	150
125	150

5.4
138 × 203 × 185.1

2NO2NC

AU-100, AU-100E (Max.4NO4NC)



MT-225/□(Q)

●
690V
690V
6kV
10A, 20
65~240A
2.5

147 × 141 × 184



400AF

MC-265a(Q)	MC-330a(Q)	MC-400a(Q)
●	●	●
3pole		
690V		
1000V		
50/60Hz		
8kV		
1200 operations per hour		
5 mil. operations		2.5 mil. operations
1 mil. operations		0.5 mil. operations
300	350	450
80	90	125
265	330	400
147	160	200
265	330	400
147	160	225
225	280	350
160	200	250
185	225	300
300	350	450
-	-	-
-	-	-
75	100	125
100	125	150
200	250	300
200	250	300
5		

9.2
163 × 243 × 204.4

2NO2NC

AU-100, AU-100E (Max.4NO4NC)



MT-400/□(Q)

●
690V
690V
6kV
10A, 20
85~400A
2.6

151 × 171 × 198



800AF

MC-500a(Q)	MC-630a(Q)	MC-800a(Q)
●	●	●
3pole		
690V		
1000V		
50/60Hz		
8kV		
1200 operations per hour		
2.5 mil. operations		0.5 mil. operations
580	660	900
147	190	220
500	630	800
265	330	440
500	630	800
265	330	500
400	500	720
300	400	500
380	420	630
580	660	900
-	-	-
-	-	-
150	200	200
200	250	300
400	500	600
400	500	600
6		7

22.4
285 × 312 × 245.3

2NO2NC

AU-100, AU-100E (Max.4NO4NC)



MT-800/□(Q)

●
690V
690V
6kV
10A, 20
200~800A
11.5

360 × 530 × 212

Contactor

MC-6a(Q)	/	R	/	AC220	60Hz	1NO1NC
Rated current		Version		Coil voltage	Frequency	Auxiliary contact
6a 6A		- Standard		AC 220 AC 220V	60 60Hz	00 None
⋮		R Reversing		⋮	50 50Hz	11 1NO1NC
800a 800A		4 4pole		⋮		22 2NO2NC
9b 9A				DC 24 DC 24V		10 1NO
⋮						01 1NC
22b 22A						

Note) See page 22, 23 for details.

Thermal Overload Relay

MT-12(Q)	/	2H	0.1
Rated current		Relay version	Relay setting current
12 12AF		2H Non-differential (2-heater)	0.1 0.1A
32 32AF			⋮
63 63AF		3H Non-differential (3-heater)	⋮
95 95AF			800 800A
⋮		3K Differential	
⋮		3D Class 20	
800 800AF			

Contactor relays

MR	/	4
		Poles
		4 4 Pole
		6 6 Pole
		8 8 Pole

Optional Accessories

Surge absorber

US11

Composition and voltage		
1	Varistor+RC	AC 24~48V
2	Varistor+RC	AC 100~125V
3	Varistor+RC	AC 200~240V
4	Varistor+RC	DC 24~48V
5	Varistor+RC	DC 100~125V
6	Varistor+RC	DC 200~220V
11	Varistor	AC/DC 24~48V
12	Varistor	AC/DC 100~125V
13	Varistor	AC/DC 200~240V
14	Varistor	AC/DC 380~440V
22	RC	AC 100~125V

Note) See page 82 for details.

Environment



Standards	IEC/EN 60947-1, IEC/EN 60947-4-1, UL508, K60947
Certifications	CE, UL, CCC
Rated insulation voltage (Ui)	1000V (6A~22A: 690V, 32A~800A: 1000V)
Rated impulse withstand voltage (Uimp)	8kV (6A~22A: 6kV, 32A~800A: 8kV)
Degree of protection	IP20 (Conforming to IEC60529)
Ambient air temperature	Storage: -50° C ~ +80° C Operation: -5° C ~ +40° C
Operating altitude	3000m (8900ft)
Operating positions	
Shock resistance (1/2 sine wave =11ms)	Opened: 8G Closed: 10G
Vibration resistance (Conforming to IEC68-2-6) (5...300 Hz)	Opened: 2G Closed: 4G
Flame resistance	Conforming to UL 94: V0 Conforming to IEC 695-2-1: 960° C

Marking

For Nuclear power plant

Metasol

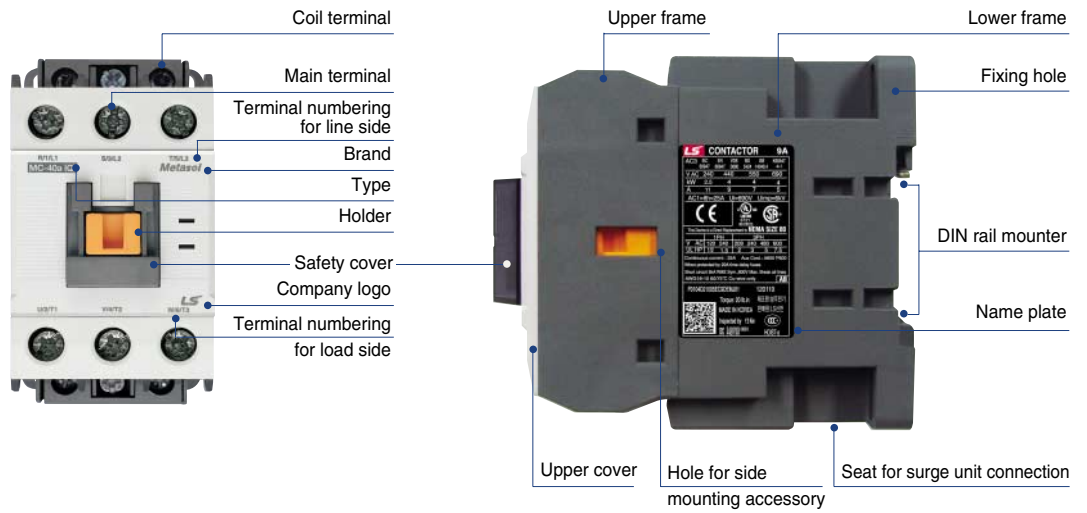

Company logo	LS	CONTACTOR	9A	Type															
	AC3 60947 60947 0660 5424 14048.4 -4-1	EN VDE BS GB K60947		Product name															
	V AC 240 440 550 690			Rating															
	kW 2.5 4 4 4																		
	A 11 9 7 5																		
CE marking	CE	UL 185	SP	UL, CSA rating															
UL size	This Device is a Direct Replacement to NEMA SIZE 00																		
Wire size	<table border="1"> <tr> <th></th> <th>1PH</th> <th colspan="3">3PH</th> </tr> <tr> <td>V AC</td> <td>120 240</td> <td>208</td> <td>240</td> <td>480 600</td> </tr> <tr> <td>UL HP</td> <td>1/2 1.5</td> <td>2</td> <td>3</td> <td>5 7.5</td> </tr> </table>				1PH	3PH			V AC	120 240	208	240	480 600	UL HP	1/2 1.5	2	3	5 7.5	A, B : Metasol MC S : Susol MC
	1PH	3PH																	
V AC	120 240	208	240	480 600															
UL HP	1/2 1.5	2	3	5 7.5															
Country of origin	P0104D21005EC9DDEMJ01 120110			Date of manufacture															
	Torque: 20 lb.in 제조원: 성우전기																		
	MADE IN KOREA 판매원: LS산전																		
	Inspected by YS Kim			Certification (Domestic use only)															
	S 002002-9001 HOISTra																		

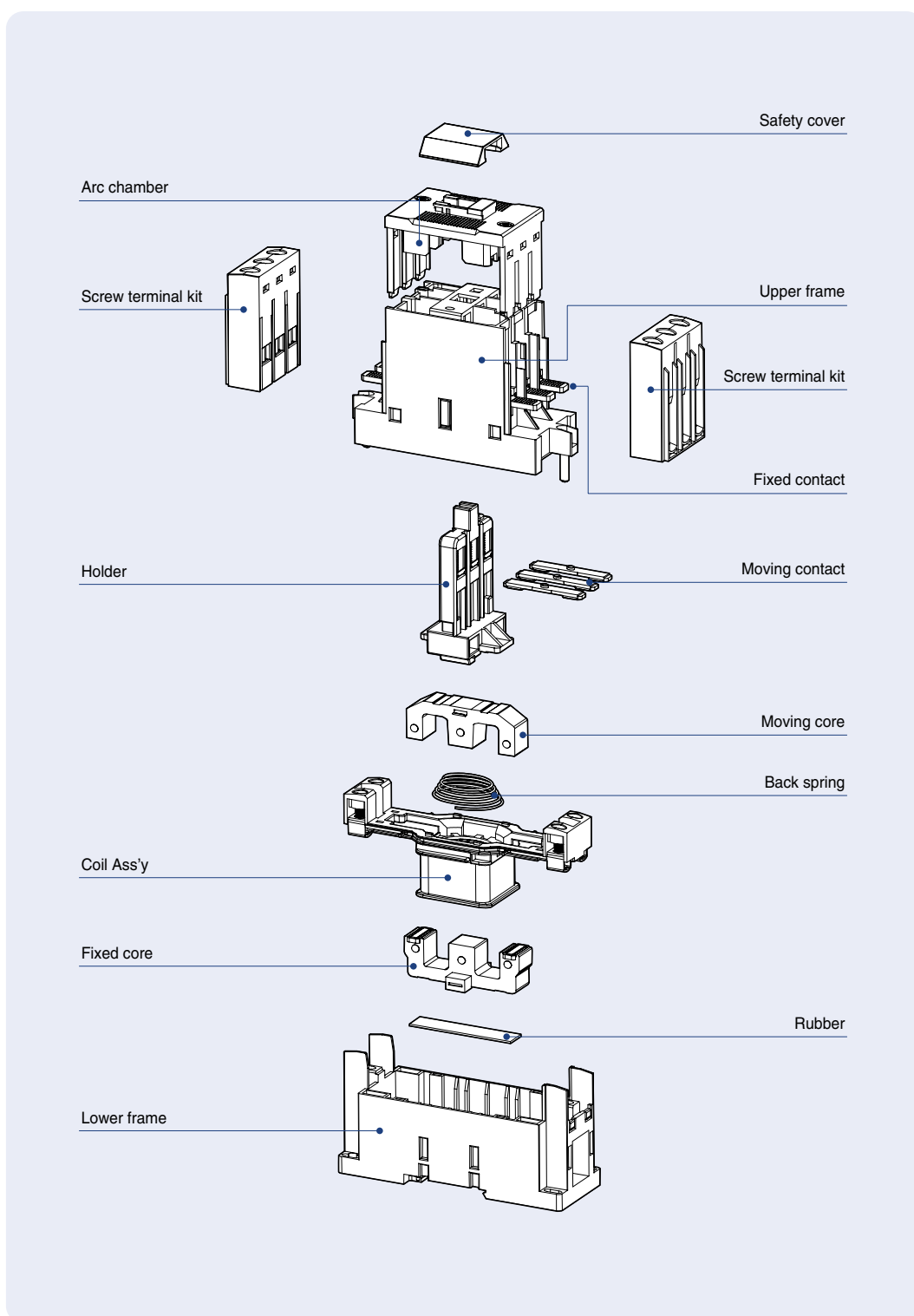

Description

- 3-pole(NO) main contact
- Finger proof design
- DIN rail or screw mountable
- AC or DC control in different physical size
- Front/side mountable accessories available
- Direct mountable overload relay available Rating
- 1NO or 1NC Auxiliary contact built-in as standard.

Rating



MC-18a(Q)

Contactor type			MC-6a(Q)		MC-9a(Q)		MC-12a(Q)		MC-18a(Q)		
			kW	A	kW	A	kW	A	kW	A	
AC duty	AC3	200/240V	2.2	9	2.5	11	3.5	13	4.5	18	
		380/440V	3	7	4	9	5.5	12	7.5	18	
		500/550V	3	6	4	7	7.5	12	7.5	13	
		690V	3	4	4	5	7.5	9	7.5	9	
	AC4	200/240V	1.5	7	1.5	8	2.2	11	3.7	16	
		380/440V	2.2	5	2.2	6	4	9	4	11	
AC1		-	25	-	25	-	25	-	32		
DC1 duty (L/R=1ms)	2-pole	24V	-	18	-	18	-	18	-	18	
		in series	48V	-	17	-	17	-	17	-	17
		110V	-	12	-	12	-	12	-	12	
	3-pole	24V	-	20	-	20	-	20	-	20	
		in series	48V	-	20	-	20	-	20	-	20
		110V	-	15	-	15	-	15	-	15	
DC2, 4 duty (L/R=15ms)	2-pole	24V	-	15	-	15	-	15	-	15	
		in series	48V	-	12	-	12	-	12	-	12
		110V	-	8	-	8	-	8	-	8	
	3-pole	24V	-	18	-	18	-	18	-	18	
		in series	48V	-	15	-	15	-	15	-	15
		110V	-	12	-	12	-	12	-	12	
Directly mountable Overload relay			MT-12(Q)								
Conductor size (solid, stranded)		AWG	18~10		16~10		16~8		14~8		
(the max. number of conducts: 2)		mm ²	1~4		1.5~4		1.5~10		2.5~10		
Conductor type			65/75°C Cu-wire only								

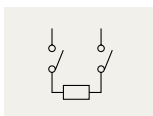

2pole for DC contact

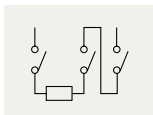

3pole for DC contact



Coil voltage

AC	50Hz	24, 32, 42, 48, 80, 100, 110, 220, 230, 240, 380, 400, 500, 550V
	60Hz	24, 48, 100, 110, 120, 200, 208, 220, 230, 240, 277, 380, 480, 600V
DC	DC	12, 20, 24, 48, 60, 80, 100, 110, 125, 200, 220, 250V

* Please be cautious for wiring control power cable, especially "+" (Positive) and "-" (Negative) polarity should be correctly considered.

Certification

- CE(IEC)
- UL508
- CCC

Accessories

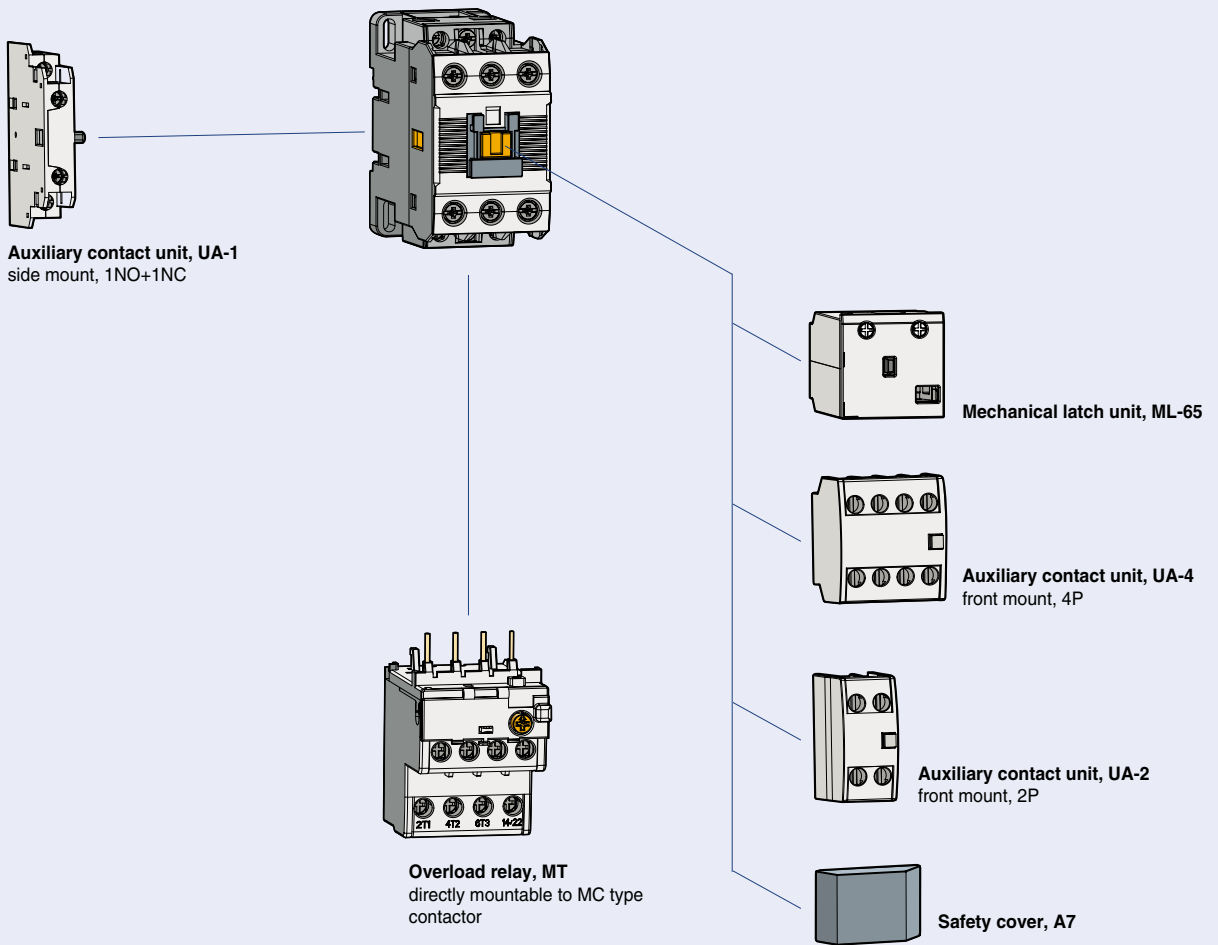

Description

- 3-pole(NO) main contact
- Finger proof design
- DIN rail or screw mountable
- AC or DC control in different physical size
- Front/side mountable accessories available
- Direct mountable overload relay available Rating
- 1NO1NC Auxiliary contact built-in as standard.
- UA-1 is available on only left side

Rating



MC-22b(Q)

Contactor type			MC-9b(Q)		MC-12b(Q)		MC-18b(Q)		MC-22b(Q)		
			kW	A	kW	A	kW	A	kW	A	
AC duty	AC3	200/240V	2.5	11	3.5	13	4.5	18	5.5	22	
		380/440V	4	9	5.5	12	7.5	18	11	22	
		500/550V	4	7	7.5	12	7.5	13	15	20	
		690V	4	5	7.5	9	7.5	9	15	18	
	AC4	200/240V	1.5	8	2.2	11	3.7	16	3.7	18	
		380/440V	2.2	6	4	9	4	11	5.5	13	
	AC1		-	25	-	25	-	32	-	40	
DC1 duty (L/R=1ms)	2-pole	24V	-	18	-	18	-	18	-	32	
		in series	48V	-	17	-	17	-	17	-	30
		110V	-	12	-	12	-	12	-	23	
	3-pole	24V	-	20	-	20	-	20	-	32	
		in series	48V	-	20	-	20	-	20	-	32
		110V	-	15	-	15	-	15	-	27	
DC 2,4 duty (L/R=15ms)	2-pole	24V	-	15	-	15	-	15	-	25	
		in series	48V	-	12	-	12	-	12	-	20
		110V	-	8	-	8	-	8	-	15	
	3-pole	24V	-	18	-	18	-	18	-	30	
		in series	48V	-	15	-	15	-	15	-	30
		110V	-	12	-	12	-	12	-	20	
Directly mountable Overload relay			MT-32(Q)								
Conductor size (solid, stranded)		AWG	16~10		16~8		14~8		14~8		
(the max. number of conducts: 2)		mm ²	1.5~4		1.5~10		2.5~10		2.5~10		
Conductor type			65/75°C Cu-wire only								

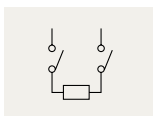

2pole for DC contact

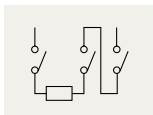

3pole for DC contact

Coil voltage

AC	50Hz	24, 32, 42, 48, 80, 100, 110, 220, 230, 240, 380, 400, 500, 550V
	60Hz	24, 48, 100, 110, 120, 200, 208, 220, 230, 240, 277, 380, 480, 600V
DC	DC	12, 20, 24, 48, 60, 80, 100, 110, 125, 200, 220, 250V

Certification
• CE(IEC)
• UL508
• CCC

* Please be cautious for wiring control power cable, especially "+" (Positive) and "-" (Negative) polarity should be correctly considered.

Accessories

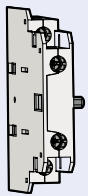

Auxiliary contact unit, UA-1
side mount, 1NO+1NC

* It is not possible to attach "UA-1" on the right side of product

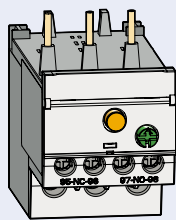
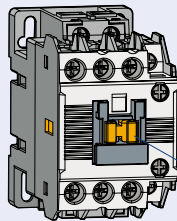

Overload relay, MT
directly mountable to MC type contactor

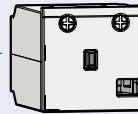

Mechanical latch unit, ML-65

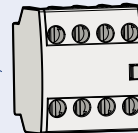

Auxiliary contact unit, UA-4
front mount, 4P



Auxiliary contact unit, UA-2
front mount, 2P

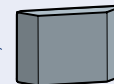

Safety cover, A7

Description

- 3-pole(NO) main contact
- Finger proof design
- DIN rail or screw mountable
- AC or DC control in different physical size
- Front/side mountable accessories available
- Direct mountable overload relay available Rating
- 2NO2NC Auxiliary contact built-in is possible as standard

Rating



MC-40a(Q)

Contactor type			MC-32a(Q)		MC-40a(Q)		
			kW	A	kW	A	
AC duty	AC3	200/240V	7.5	32	11	40	
		380/440V	15	32	18.5	40	
		500/550V	18.5	28	22	32	
		690V	18.5	20	22	23	
	AC4	200/240V	4.5	20	5.5	25	
		380/440V	7.5	17	11	24	
	AC1		-	50	-	60	
DC1 (L/R=1ms)	2-pole	24V	-	32	-	55	
		in series	48V	-	30	-	55
		110V	-	25	-	40	
	3-pole	24V	-	32	-	55	
		in series	48V	-	32	-	55
		110V	-	27	-	45	
DC2,4 (L/R=15ms)	2-pole	24V	-	25	-	30	
		in series	48V	-	20	-	25
		110V	-	15	-	20	
	3-pole	24V	-	30	-	45	
		in series	48V	-	30	-	40
		110V	-	20	-	30	
Directly mountable Overload relay			MT-32(Q)				
Conductor size (solid, stranded) (the max. number of conducts: 2)		AWG	12~8		8~6		
		mm ²	2.5~10		10~16		
Conductor type			65/75°C Cu-wire only				

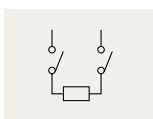

2pole for DC contact

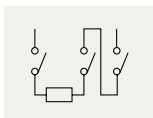

3pole for DC contact



Coil voltage

AC	50Hz	24, 32, 42, 48, 80, 100, 110, 220, 230, 240, 380, 400, 500, 550V
	60Hz	24, 48, 100, 110, 120, 200, 208, 220, 230, 240, 277, 380, 480, 600V
DC	DC	12, 20, 24, 48, 60, 80, 100, 110, 125, 200, 220, 250V

Certification

- CE(IEC)
- UL508
- CCC

Accessories

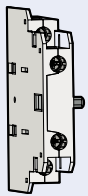

Auxiliary contact unit, UA-1
side mount, 1NO+1NC

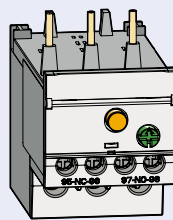
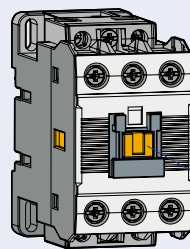

Overload relay, MT
directly mountable to MC type
contactor

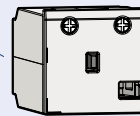

Mechanical latch unit, ML-65

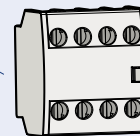

Auxiliary contact unit, UA-4
front mount, 4P



Auxiliary contact unit, UA-2
front mount, 2P

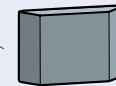

Safety cover, A7

Description

- 3-pole(NO) main contact
- Finger proof design
- DIN rail or screw mountable
- AC or DC control in different physical size
- Front/side mountable accessories available
- Direct mountable overload relay available rating
- 2NO2NC Auxiliary contact built-in is possible as standard

Rating



MC-65a(Q)

Contactor type			MC-50a(Q)		MC-65a(Q)		
			kW	A	kW	A	
AC duty	AC3	200/240V	15	55	18.5	65	
		380/440V	22	50	30	65	
		500/550V	30	43	33	60	
		690V	30	28	33	35	
	AC4	200/240V	7.5	35	11	50	
		380/440V	15	32	22	47	
	AC1		-	70	-	100	
	DC1 duty (L/R=1ms)	2-pole	24V	-	70	-	90
			in series	48V	-	70	-
110V			-	50	-	75	
3-pole		24V	-	70	-	90	
		in series	48V	-	70	-	90
		110V	-	60	-	80	
DC2, 4 duty (L/R=15ms)	2-pole	24V	-	45	-	55	
		in series	48V	-	40	-	45
		110V	-	25	-	38	
	3-pole	24V	-	55	-	75	
		in series	48V	-	50	-	65
		110V	-	35	-	55	
Directly mountable Overload relay			MT-63(Q)				
Conductor size (solid, stranded) (the max. number of conducts: 2)		AWG	10~4		8~3		
		mm ²	6~25		10~35		
Conductor type			65/75°C Cu-wire only				

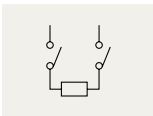

2pole for DC contact

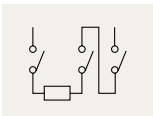

3pole for DC contact



Coil voltage

AC	50Hz	24, 32, 42, 48, 80, 100, 110, 220, 230, 240, 380, 400, 500, 550V
	60Hz	24, 48, 100, 110, 120, 200, 208, 220, 230, 240, 277, 380, 480, 600V
DC	DC	12, 20, 24, 48, 60, 80, 100, 110, 125, 200, 220, 250V

Certification

- CE(IEC)
- UL508
- CCC

Accessories

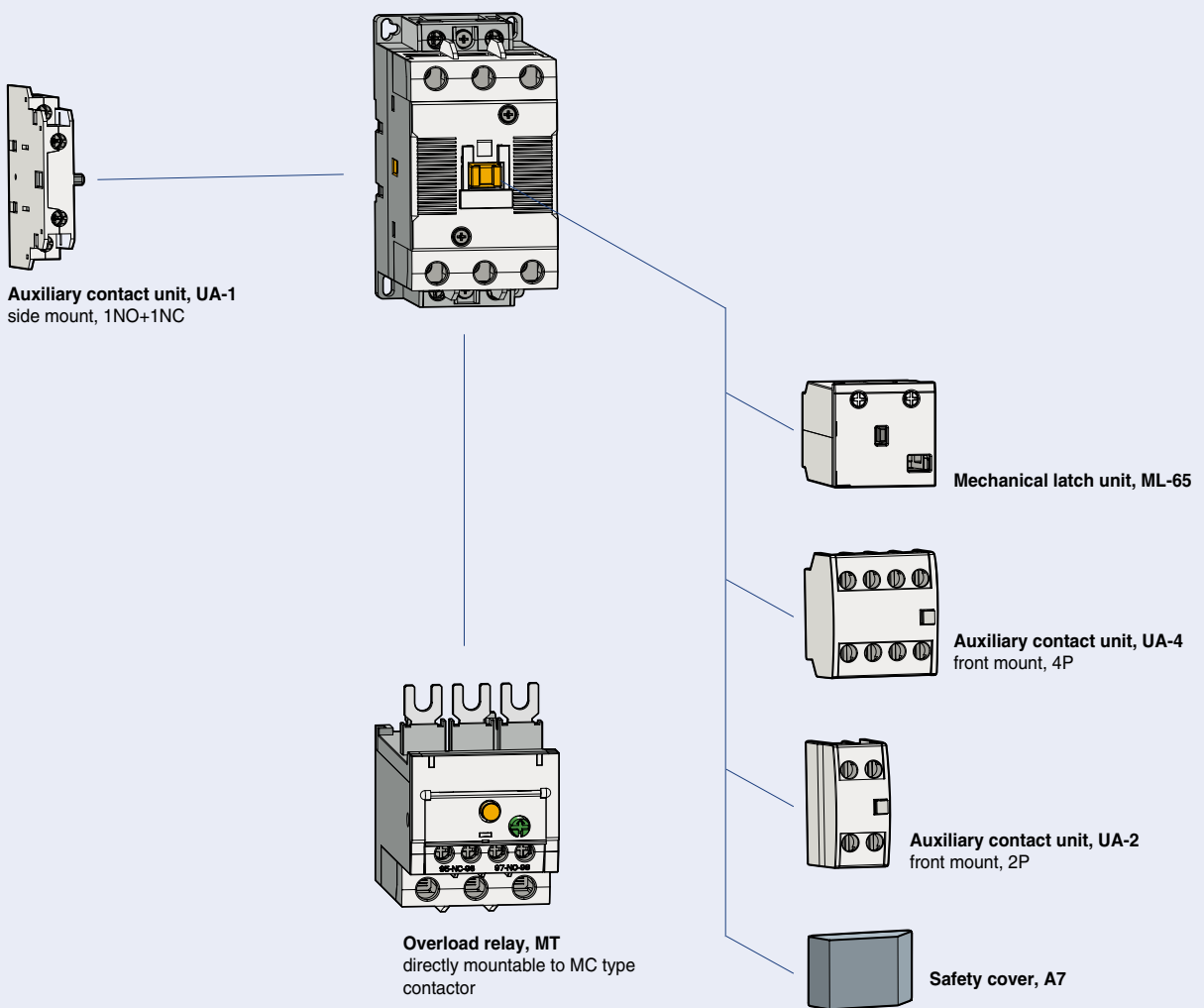

Description

- 3-pole(NO) main contact
- Finger proof design
- DIN rail or screw mountable
- AC or DC control in different physical size
- Front/side mountable accessories available
- Direct mountable overload relay available Rating
- 2NO2NC Auxiliary contact built-in is possible as standard

Rating



MC-100a(Q)

Contactor type			MC-100a(Q)		MC-130a(Q)		MC-150a(Q)		
			kW	A	kW	A	kW	A	
AC duty	AC3	200/240V	30	105	37	130	45	150	
		380/440V	55	105	60	130	75	150	
		500/550V	55	85	60	90	70	100	
		690V	45	65	55	60	55	60	
	AC4	200/240V	19	80	22	93	30	120	
		380/440V	37	75	45	90	55	110	
	AC1		-	160	-	160	-	210	
DC1 duty (L/R=1ms)	2-pole	24V	-	100	-	120	-	150	
		in series	48V	-	100	-	100	-	120
		110V	-	80	-	80	-	100	
	3-pole	24V	-	100	-	120	-	150	
		in series	48V	-	100	-	120	-	150
		110V	-	85	-	100	-	150	
DC2, 4 duty (L/R=15ms)	2-pole	24V	-	60	-	120	-	150	
		in series	48V	-	50	-	60	-	100
		110V	-	40	-	40	-	80	
	3-pole	24V	-	80	-	120	-	150	
		in series	48V	-	70	-	90	-	130
		110V	-	60	-	80	-	120	
Directly mountable Overload relay			MT-150(Q)						
Conductor size (solid, stranded)	AWG		8~00		3~00		3~4/0		
	(the max. number of conducts: 2)	mm ²	10~70		35~70		35~95		
Conductor type			65/75°C Cu-wire only						

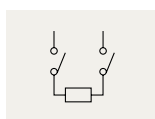

2pole for DC contact

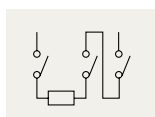

3pole for DC contact



Coil voltage

AC	50Hz	24, 32, 42, 48, 80, 100, 110, 220, 230, 240, 380, 400, 500, 550V
	60Hz	24, 48, 100, 110, 120, 200, 208, 220, 230, 240, 277, 380, 480, 600V
DC	DC	12, 20, 24, 48, 60, 80, 100, 110, 125, 200, 220, 250V

Certification

- CE(IEC)
- UL508
- CCC

Accessories

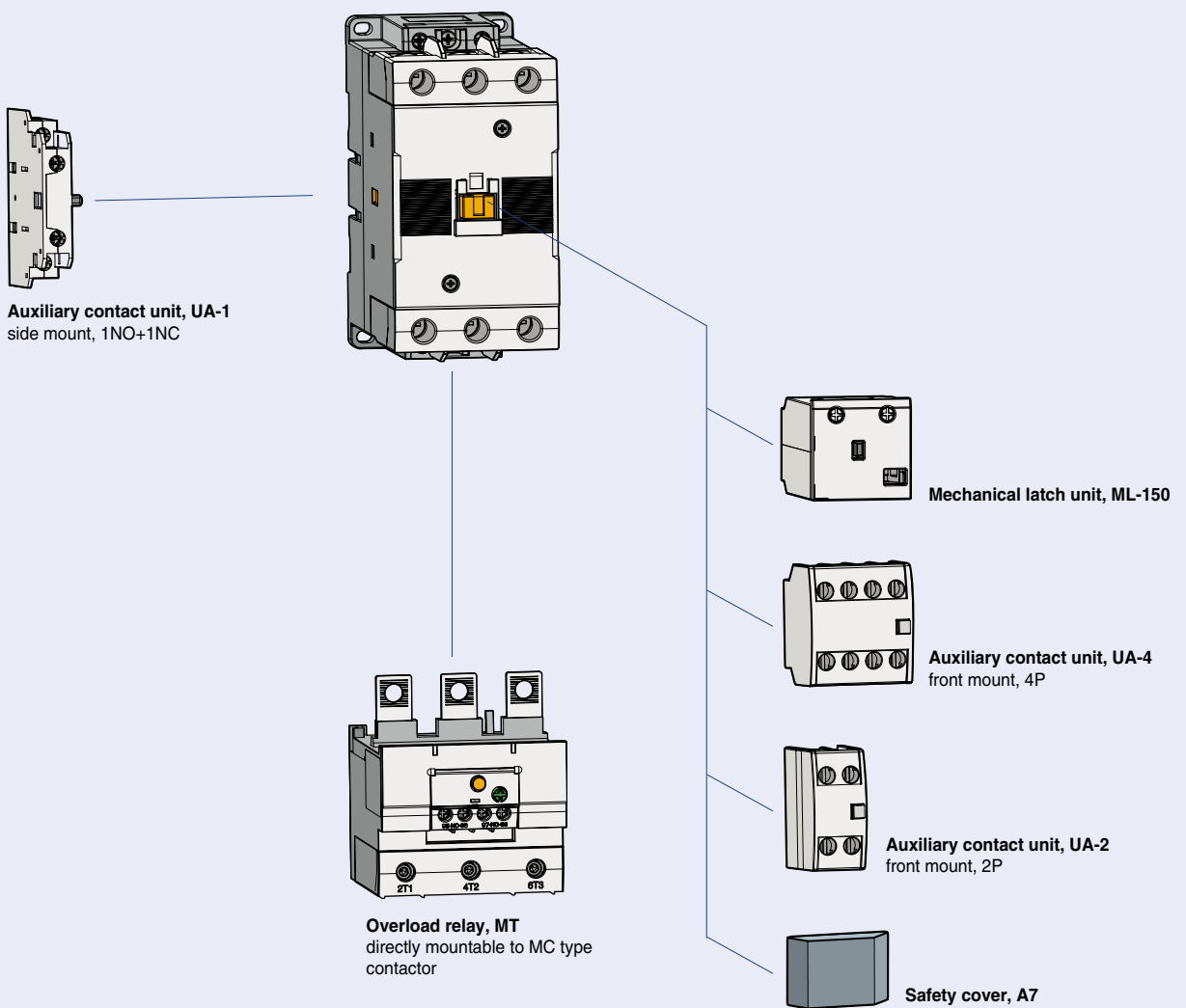

Description

- 3-pole main contact
- AC/DC common use coil built
- Wide coil operation voltage
- Screw mountable
- 2NO+2NC Auxiliary contacts built-in as standard
- Top/side mountable accessories available
- Direct mountable overload relays available

Rating



MC-225a(Q)

Contactor type			MC-185a(Q)		MC-225a(Q)		
			kW	A	kW	A	
AC duty	AC3	200/240V	55	185	75	225	
		380/440V	90	185	132	225	
		500/550V	110	180	132	200	
		690V	110	120	140	150	
	AC4	200/240V	37	150	45	180	
		380/440V	75	150	90	180	
	AC1		-	230	-	275	
DC1 duty (L/R=1ms)	2-pole	24V	-	180	-	220	
		in series	48V	-	180	-	180
		110V	-	150	-	150	
	3-pole	24V	-	180	-	220	
		in series	48V	-	180	-	220
		110V	-	180	-	220	
DC2, 4 duty (L/R=15ms)	2-pole	24V	-	180	-	220	
		in series	48V	-	150	-	150
		110V	-	120	-	120	
	3-pole	24V	-	180	-	220	
		in series	48V	-	180	-	220
		110V	-	150	-	150	
Directly mountable Overload relay			MT-225(Q)				
Conductor size (solid, stranded) (the max. number of conducts: 2)	AWG		1~4/0		0~300		
	mm ²		50~95		50~150		
Conductor type			75°C Cu stranded wire				

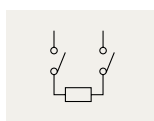

2pole for DC contact

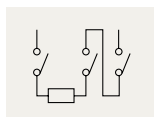

3pole for DC contact



Coil voltage, AC/DC common

Nominal(ordering) voltage	AC 50/60Hz	DC
24V	24 - 25V	24V
48V	48 - 50V	48V
100/200V	100 - 240V	100 - 220V
300V	265 - 347V	-
400V	380 - 450V	-
500V	440 - 575V	-

Certification

- CE(IEC)
- UL508
- CCC

Accessories

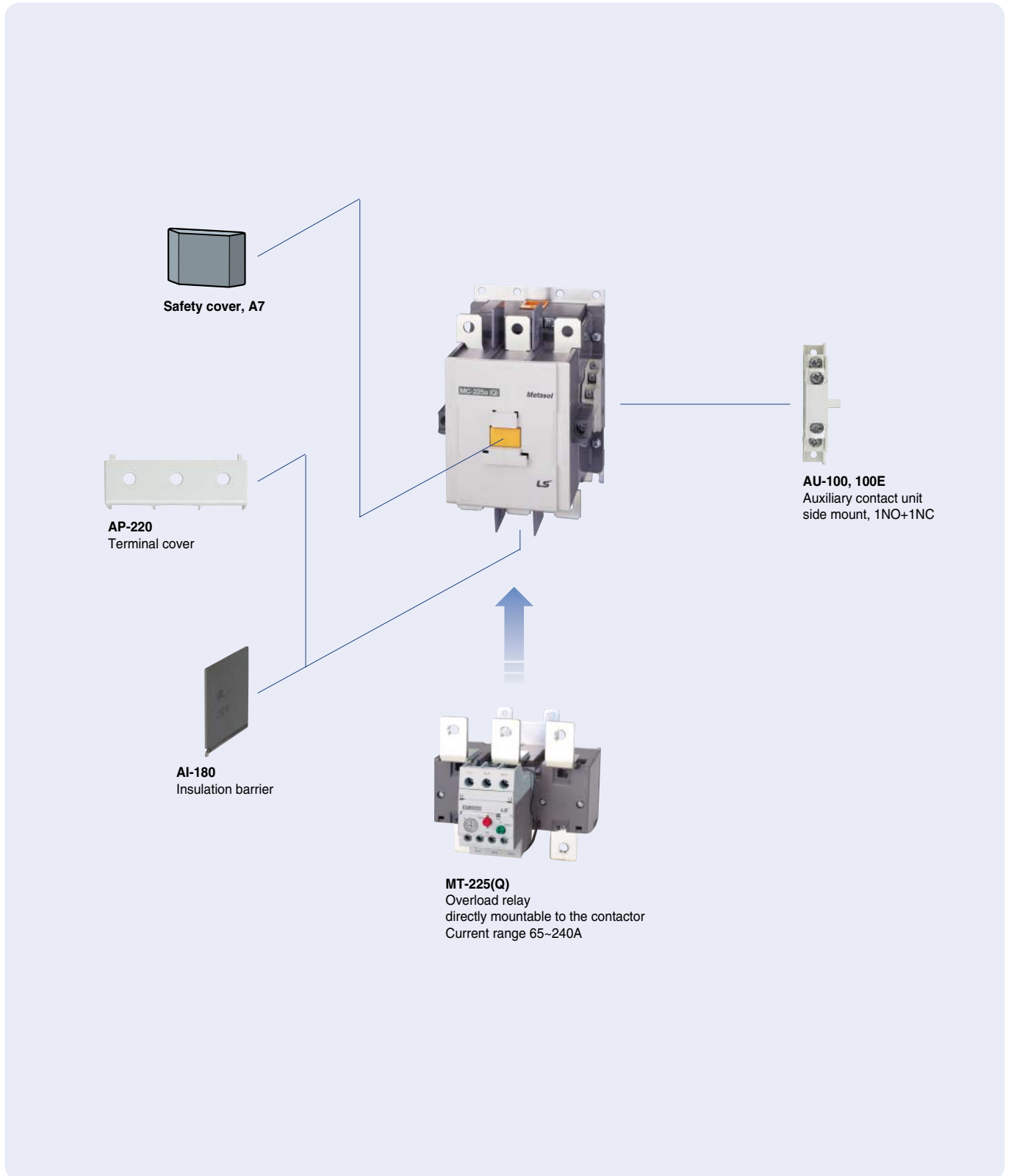

Description

- 3-pole main contact
- AC/DC common use coil built
- Wide coil operation voltage
- Screw mountable
- 2NO+2NC Auxiliary contacts built-in as standard
- Top/side mountable accessories available
- Direct mountable overload relays available

Rating



MC-400a(Q)

Contactor type			MC-265a(Q)		MC-330a(Q)		MC-400a(Q)		
			kW	A	kW	A	kW	A	
AC duty	AC3	200/240V	80	265	90	330	125	400	
		380/440V	147	265	160	330	200	400	
		500/550V	147	225	160	280	225	350	
		690V	160	185	200	225	250	300	
	AC4	200/240V	50	200	55	220	75	300	
		380/440V	102	200	110	220	150	300	
	AC1		-	300	-	350	-	450	
DC1 duty (L/R=1ms)	2-pole	24V	-	220	-	300	-	400	
		in series	48V	-	180	-	240	-	240
		110V	-	150	-	200	-	200	
	3-pole	24V	-	220	-	300	-	400	
		in series	48V	-	220	-	300	-	400
		110V	-	220	-	300	-	400	
DC2, 4 duty (L/R=15ms)	2-pole	24V	-	220	-	300	-	400	
		in series	48V	-	150	-	200	-	200
		110V	-	120	-	150	-	150	
	3-pole	24V	-	220	-	300	-	400	
		in series	48V	-	220	-	280	-	280
		110V	-	150	-	200	-	200	
Directly mountable Overload relay			MT-400(Q)						
Conductor size (solid, stranded)	AWG		3/0~500		4/0~500		350~700		
	mm ²		95~240		95~240		185~370		
Conductor type			75°C Cu stranded wire						

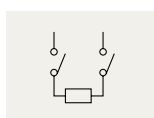

2pole for DC contact

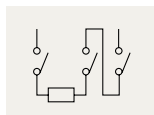

3pole for DC contact



Coil voltage, AC/DC common

Nominal(ordering) voltage	AC 50/60Hz	DC
100/200V	100 - 240V	100 - 220V
300V	265 - 347V	-
400V	380 - 450V	-
500V	440 - 575V	-

Certification

- CE(IEC)
- UL508
- CCC

Accessories

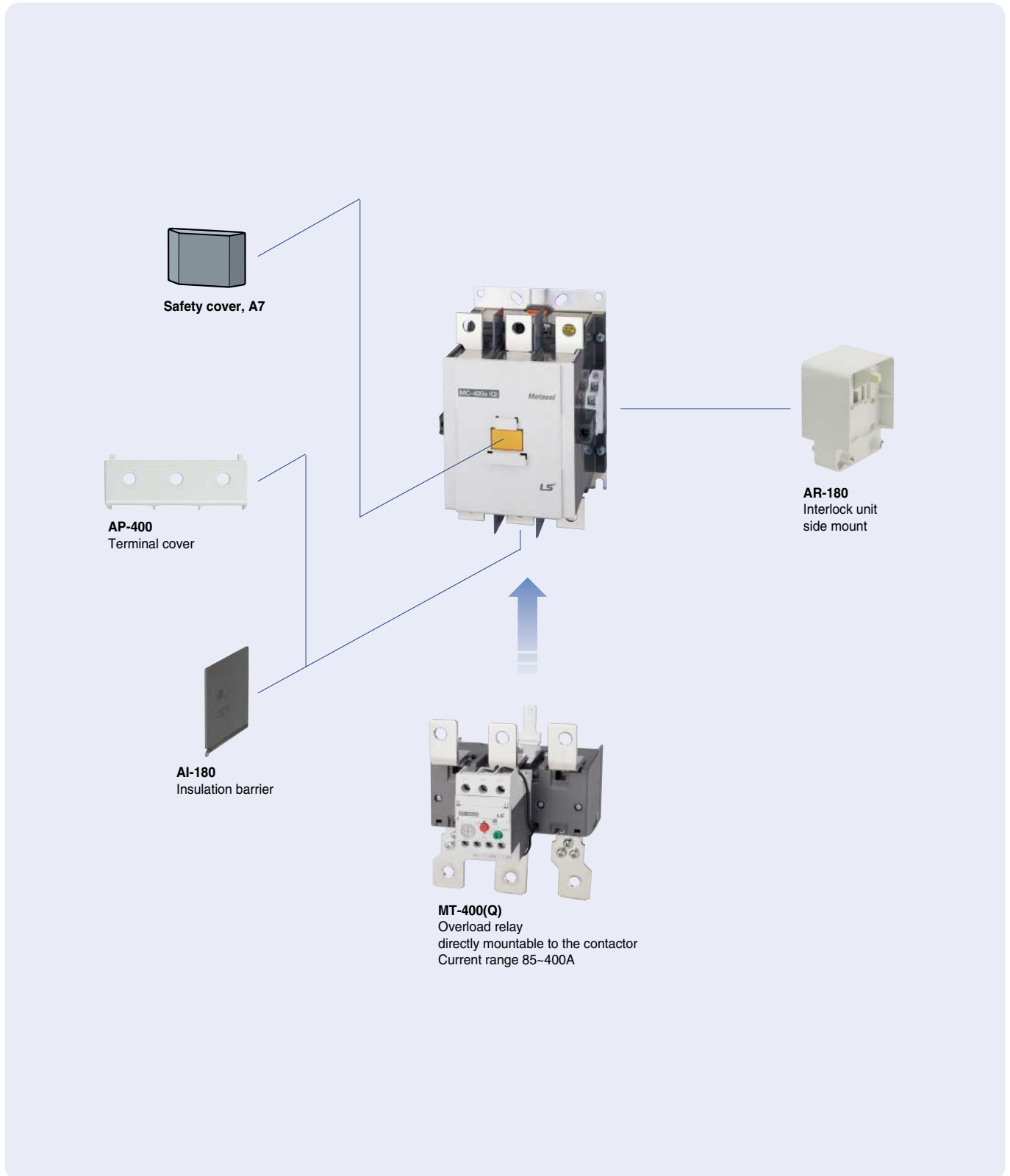

Description

- 3-pole main contact
- AC/DC common use coil built
- Wide coil operation voltage
- Screw mountable
- 2NO+2NC Auxiliary contacts built-in as standard
- Top/side mountable accessories available
- Overload relays available



MC-800a(Q)

Rating

Contactor type			MC-500a(Q)		MC-630a(Q)		MC-800a(Q)		
			kW	A	kW	A	kW	A	
AC duty	AC3	200/240V	147	500	190	630	220	800	
		380/440V	265	500	330	630	440	800	
		500/550V	265	400	330	500	500	720	
		690V	300	380	400	420	500	630	
	AC4	200/240V	90	350	110	400	160	630	
		380/440V	176	350	200	400	300	630	
AC1		-	580	-	660	-	900		
DC1 duty (L/R=1ms)	2-pole	24V	-	400	-	630	-	800	
		in series	48V	-	240	-	630	-	800
		110V	-	200	-	630	-	630	
	3-pole	24V	-	400	-	630	-	800	
		in series	48V	-	400	-	630	-	800
		110V	-	400	-	630	-	800	
DC2, 4 duty (L/R=15ms)	2-pole	24V	-	400	-	630	-	800	
		in series	48V	-	200	-	630	-	630
		110V	-	150	-	630	-	630	
	3-pole	24V	-	400	-	630	-	800	
		in series	48V	-	280	-	630	-	630
		110V	-	200	-	630	-	630	
Directly mountable Overload relay			MT-800(Q)						
Conductor size (solid, stranded) (the max. number of conducts: 2)	AWG		350~800		600~2000		1700~Busbar		
	mm ²		185~480		-		-		
Conductor type			75°C Cu stranded wire						

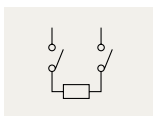

2pole for DC contact

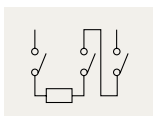

3pole for DC contact



Coil voltage, AC/DC common

Nominal(ordering) voltage	AC 50/60Hz	DC
100V	100 - 127V	100 - 110V
200V	200 - 240V	200 - 220V
300V	265 - 347V	-
400V	380 - 450V	-
500V	440 - 575V	-

Certification
• CE(IEC)
• UL508
• CCC

Accessories

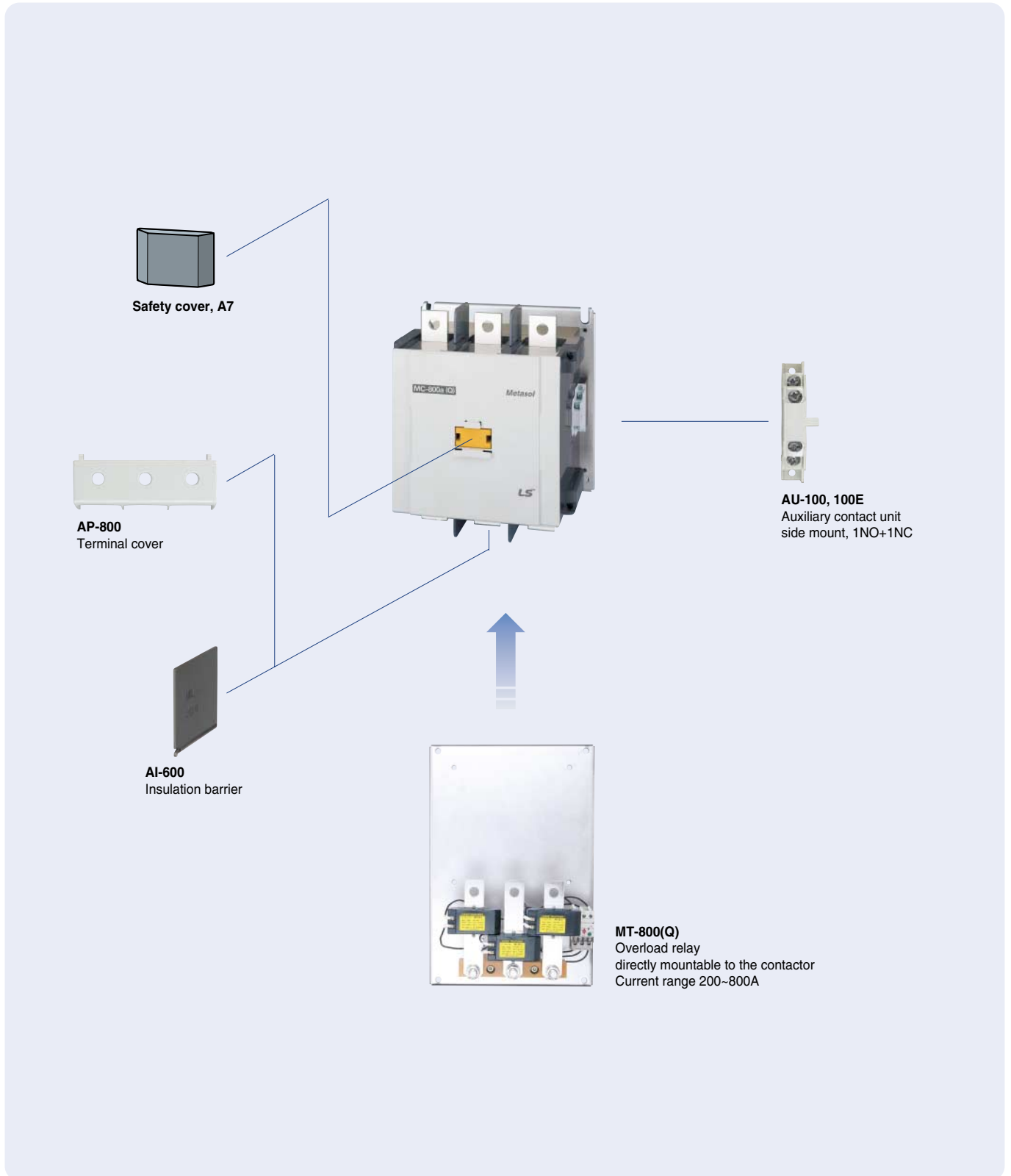

Description

- 4,6,8 pole units
- AC/DC control voltage
- 16A continuous current, lth
- DIN rail or screw mountable

Selection



MR-4(Q)



MR-6(Q)



MR-8(Q)

Poles	Composition	Types	Remarks
4 Pole	4NO 3NO1NC 2NO2NC 1NO3NC 4NC	MR-4(Q)	Additional auxiliary contacts can be mounted on the relays.
6 Pole	6NO 5NO1NC 4NO2NC 3NO3NC 2NO4NC	MR-6(Q)	UA-2 is mounted on the MR-4.
8 Pole	8NO 7NO1NC 6NO2NC 5NO3NC 4NO4NC	MR-8(Q)	UA-4 is mounted on the MR-4.

Ratings

Rated insulation voltage (Ui)		AC 690V					
Continuous current (lth)		16A					
Operating cycle		1800 operations/hour					
Endurance	Mechanical life time	10 mil. Operations					
	Electrical life time	0.25 mil. Operations					
Type			MR-4(Q)	MR-6(Q)	MR-8(Q)		
AC-15	Rated current (A)	120V	6	6	6		
		240V	3	3	3		
		380V	1.9	1.9	1.9		
		480V	1.5	1.5	1.5		
		500V	1.4	1.4	1.4		
		600V	1.2	1.2	1.2		
DC-13	Rated current (A)		MR-4(Q)	MR-4(Q)	UA-2(Q)	MR-4(Q)	UA-4(Q)
		125V	1.1	1.1	0.55	1.1	0.55
		250V	0.55	0.55	0.27	0.55	0.27
		400V	0.31	0.31	0.15	0.31	0.15
		500V	0.27	0.27	0.13	0.27	0.13
	600V	0.2	0.2	0.1	0.2	0.1	

This product is designed for Nuclear power plant.
You can identify by "Q" sticker on the product, however, the nameplate does NOT contain any information to identify.



Coil voltage

AC	50Hz	24, 32, 36, 42, 48, 60, 80, 100, 110, 220, 230, 240, 380, 400, 415, 440, 500, 550V
	60Hz	24, 48, 100, 110, 120, 200, 208, 220, 230, 240, 277, 380, 440, 480, 600V
	50/60Hz	24, 48, 100, 110, 120, 200, 230, 240, 380, 415, 440, 500, 550V
DC	DC	12, 20, 24, 48, 60, 80, 100, 110, 125, 200, 220, 250V

Auxiliary contact units

- 2 and 4 pole
- Side and front mountable
- Common use for Metasol contactors from MC-6a(Q) to MC-150a(Q)
- Auxiliary contact meet the requirements for mirror contacts in IEC 60947-4-1. Annex F (A mirror contact is an auxiliary NC contact that cannot be closed simultaneously with a NO main contact)
- Product indicated "Low" is for Low current application

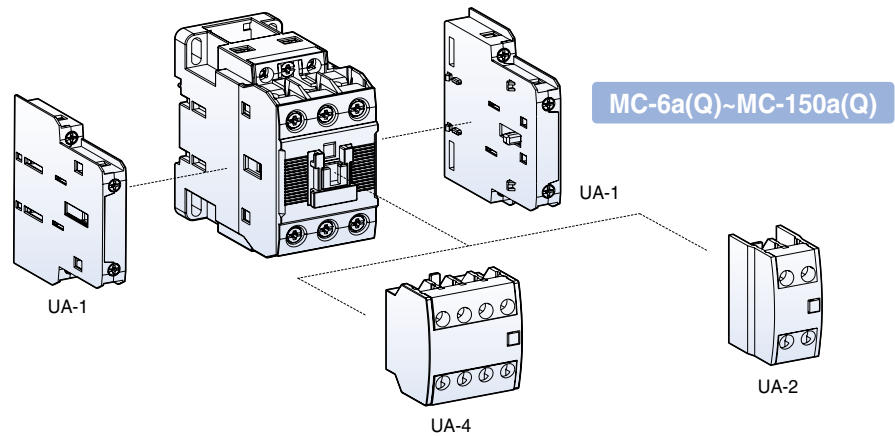

Selection

Type	Appearance	Pole	Composition		Contact arrangement	Mount	Weight
			NO	NC			
UA-1		2	1	1		Side	53g
UA-2		2	2	-		Front	28g
			1	1			
UA-4		4	4	-		Front	50g
			3	1			
			2	2			
			1	3			
			-	4			

Maximum combination of contact units

MC-6a(Q)-18a(Q), 9b(Q)-22b(Q) (Max. 3a3b)	MC-32a(Q)-150a(Q) (Max. 4a4b)
UA-4(on front)+UA-1 × 1EA (1EA on one side)	UA-4(on front)+UA-1 × 2EA (1EA on both sides)
UA-2(on front)+UA-1 × 1EA (1EA on one side)	UA-2(on front)+UA-1 × 2EA (1EA on both sides)
UA-1 × 2EA (1EA on both sides)	UA-1 × 4EA (2EA on both sides) *For AC Coil

*To use UA-1, MC-9b-22b Type is available on only left side

Auxiliary contact units

- 2 pole
- Side mountable
- Common use for Metasol contactors from MC-185a(Q) to MC-800a(Q)
- Auxiliary contact meet the requirements for mirror contacts in IEC 60947-4-1. Annex F
(A mirror contact is an auxiliary NC contact that cannot be closed simultaneously with a NO main contact)

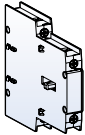
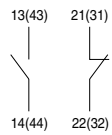

Selection

Type	Appearance	Pole	Composition		Contact arrangement	Mount	Weight
			NO	NC			
AU-100 AU-100E		2	1	1		Side	53g

Maximum combination of contact units

MC-185a(Q) ~ 800a(Q) (Max. 4a4b)

AU-100 × 4EA (2EA on both sides)

AU-100E × 4EA (2EA on both sides)

Rating

Type		UA-1	UA-2, 4	UA-1, 2, 4 Low	AU-100	AU-100E
Rated operation voltage (Ue)		600V	600V	600V	600V	60V
Rated insulation voltage (Ui)		600V	600V	600V	600V	600V
Rated impulse withstand voltage (Uimp)		6kV	6kV	6kV	6kV	6kV
Rated frequency		50/60Hz	50/60Hz	50/60Hz	50/60Hz	50/60Hz
Contact sensibility						
	Voltage	DC 17V	DC 24V	DC 5V	DC 24V	DC 7V
	Current	DC 5mA	DC 10mA	DC 3mA	DC 10mA	DC 5mA
Rated thermal current (Ith, AC12 duty)		10A	16A	16A	16A	1A
Rated operation current						
Rated operation current	AC15 duty (A600)	120V	6A	6A	6A	AC/DC 24V 0.1A AC/DC 50V 0.01A
		240V	3A	3A	3A	
		380V	1.9A	1.9A	1.9A	
		480V	1.5A	1.5A	1.5A	
		500V	1.4A	1.4A	1.4A	
	DC13 duty (Q600)	125V	1.1A	1.1A	1.1A	
		250V	0.55A	0.55A	0.55A	
		400V	0.31A	0.31A	0.31A	
		500V	0.27A	0.27A	0.27A	
		600V	0.2A	0.2A	0.2A	
Rated	1s	100A	-	-	100A	-
Short-time	0.5s	125A	-	-	120A	-
withstand current	0.1s	145A	-	-	140A	-
Electrical lifetime (mil. operations)						
Rated operation current	AC15 duty	220V	0.25	0.25	0.25	1
		440V	0.25	0.25	0.25	
	DC13 duty	220V	0.25	0.25	0.25	
		440V	0.25	0.25	0.25	
Maximum operating cycles per hour		1800	1800	1800	1800	1200
Conductor size (Solid, stranded)	AWG	18~10	18~10	18~10	18~10	18~10
	(the max. number of conducts: 2) mm ²	1~2.5	1~2.5	1~2.5	1~2.5	1~2.5

Installation

UA-1

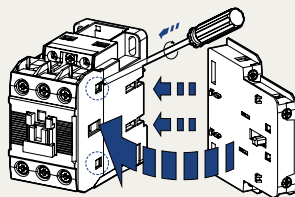

To install side mounting unit remove the indicated part in the circle in the fig. first. And then fit each part as shown. To separate push forward and pull.

UA-2, 4

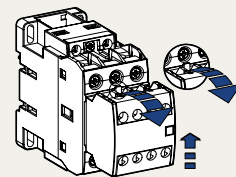

To install front mounting unit fit it on the upper part of the front of the contactor and push it down. To separate pull the lever of the unit and push the unit upward.

General descriptions

Type MT, bimetal-style, overload relays are designed to protect AC circuits and motors against overloads, phase failure, long starting times and prolonged stalling of the motor.

Four versions are available according to the protection function and trip class as below.

1. Non-differential: 3pole-2bimetal(heater) and trip class 10A
2. Non-differential: 3pole-3bimetal(heater) and trip class 10A
3. Differential: 3pole-3bimetal(heater) and trip class 10A
4. Differential: 3pole-3bimetal(heater) and trip class 20

Configuration of the front

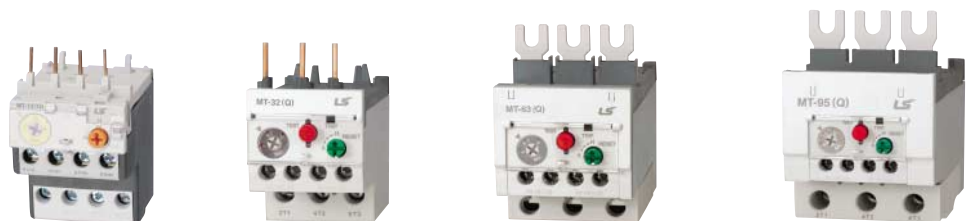
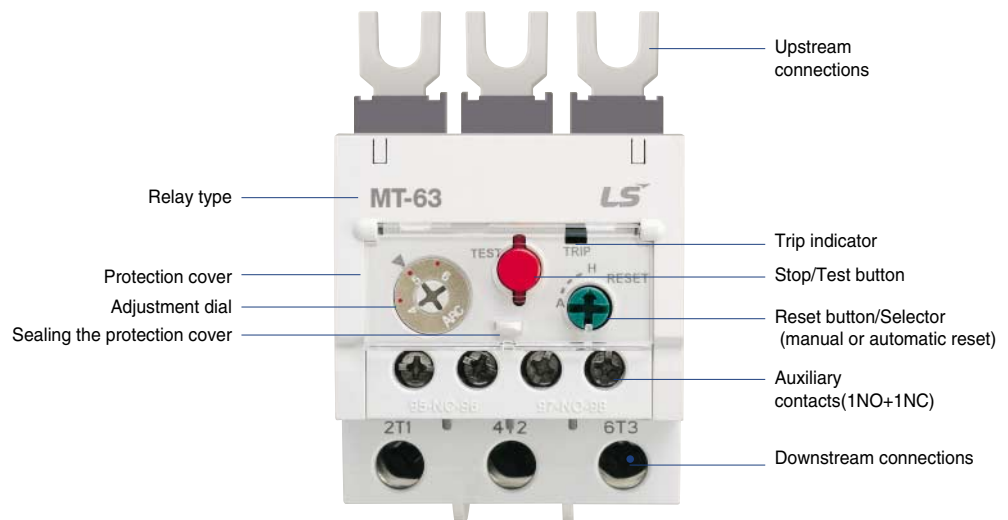

Environment and auxiliary circuit

Environment			MT-12(Q) ~ 800(Q)
Standards			IEC/EN 60947-1, IEC/EN 60947-4-1
Certifications			CE, CSA, UL, CCC
Rated operation voltage			Max. 690V
Rated insulation voltage			690V
Rated frequency			50/60Hz
Degree of protection (Conforming to IEC 60 529)			IP 20
Ambient air temperature	Storage		-55 ~ +80° C
	Operation		-5 ~ +40° C
Mounting position			Vertical plane
Shock resistance (Conforming to IEC 68-2-7)			15gn - 11ms
Vibration resistance (Conforming to IEC68-2-6)			6G
Insulation strength (Conforming to IEC 255-5)			6kV
Rated impulse withstand voltage (Conforming to IEC 801-5)			6kV
Auxiliary contacts characteristics			
Composition			1NO +1NC
Rated thermal current			5A
Rated operation current			C600, R300
AC15 duty (C600)	120V		1.5A
	240V		0.75A
	380V		0.47A
	480V		0.375A
	500V		0.35A
	600V		0.3A
DC13 duty (R300)	120V		0.22A
	240V		0.1A
Connecting conductor	Size		18AWG /1mm ²
Connection to screw clamp terminals	Type		65/75°C Cu-wire

MT-150(Q)



MT-225(Q)



MT-400(Q)



MT-800(Q)



MT type Thermal Overload Relays



Frame size		
Trip class		
Type	Non-differential(3P-2 heater)	
	Non-differential(3P-3 heater)	
	Differential type	
Terminal type		
Number of poles		
Rated operational voltage (Ue)		
Rated insulation voltage (Ui)		
Rated impulse voltage (Uimp)		
Degree of protection (IEC 60 529)		
Temperature compensation (°C)		
Functions	Trip indicating	
	Stop	
	Test	
	Manual/Automatic Reset	
Setting range(A)		
Nominal current rating	Wire size	
	mm ²	AWG
0.14	1	18
0.21		
0.33		
0.52		
0.82		
1.3		
2.1		
3.3		
5		
6.5		
7.5	1~1.5	18~16
8.5		
11	1.5~2.5	16~14
15	2.5	14~12
19	2.5~4	12~10
21.5		
27	4~6	10
30	4~10	10~8
34	6~10	10~8
42	10	8
54		
65		
74	16~25	6~4
83	25~35	4~3
90		
Applied contactors		
Separate mounting unit		

18AF	
10A	20
MT-12/2H□(Q)	-
MT-12/3H□(Q)	-
MT-12/3K□(Q)	MT-12/3D□(Q)
Screw clamp	
3	
690V	
Up to 690V	
6kV	
IP 20	
-5~+40°C	
■	
-	
■	
■	
0.1~18A	1~18A
0.1~0.16	
0.16~0.25	
0.25~0.4	
0.4~0.63	
0.63~1	
1~1.6	1~1.6
1.6~2.5	1.6~2.5
2.5~4	2.5~4
4~6	4~6
5~8	5~8
6~9	6~9
7~10	7~10
9~13	9~13
12~18	12~18
MC-6a(Q), 9a(Q), 12a(Q), 18a(Q)	
UZ-12	



40AF	
10A	20
MT-32/2H□(Q)	-
MT-32/3H□(Q)	-
MT-32/3K□(Q)	MT-32/3D□(Q)
Screw clamp	
3	
690V	
Up to 690V	
6kV	
IP 20	
-5~+40°C	
■	
■	
■	
■	
0.1~40A	1~40A
0.1~0.16	
0.16~0.25	
0.25~0.4	
0.4~0.63	
0.63~1	
1~1.6	1~1.6
1.6~2.5	1.6~2.5
2.5~4	2.5~4
4~6	4~6
5~8	5~8
6~9	6~9
7~10	7~10
9~13	9~13
12~18	12~18
16~22	16~22
18~25	18~25
22~32	22~32
-	-
28~40	28~40
MC-9b(Q), 12b(Q), 18b(Q), 22b(Q), 32a(Q), 40a(Q)	
UZ-32	

65AF	
10A	20
MT-63/2H□(Q)	-
MT-63/3H□(Q)	-
MT-63/3K□(Q)	MT-63/3D□(Q)
Screw/Lug clamp	
3	
690V	
Up to 690V	
6kV	
IP 20	
-5~+40°C	
■	
■	
■	
■	
■	
4~65A	
4~6	4~6
5~8	5~8
6~9	6~9
7~10	7~10
9~13	9~13
12~18	12~18
16~22	16~22
18~25	18~25
-	-
24~36	24~36
28~40	28~40
34~50	34~50
45~65	45~65
MC-50a(Q), 65a(Q)	
UZ-63	

100AF	
10A	20
MT-95/2H□(Q)	-
MT-95/3H□(Q)	-
MT-95/3K□(Q)	MT-95/3D□(Q)
Screw/Lug clamp	
3	
690V	
Up to 690V	
6kV	
IP 20	
-5~+40°C	
■	
■	
■	
■	
■	
7~100A	
7~10	7~10
9~13	9~13
12~18	12~18
16~22	16~22
18~25	18~25
-	-
24~36	24~36
28~40	28~40
34~50	34~50
45~65	45~65
54~75	54~75
63~85	63~85
70~95	70~95
80~100	80~100
MC-75a(Q), 85a(Q), 100a(Q)	
UZ-95	

MT type Thermal Overload Relays



Frame size		
Trip class		
Type	Non-differential(3P-2 heater)	
	Non-differential(3P-3 heater)	
	Differential type	
Terminal type		
Number of poles		
Rated operational voltage (Ue)		
Rated insulation voltage (Ui)		
Rated impulse voltage (Uimp)		
Degree of protection (IEC 60 529)		
Temperature compensation (° C)		
Functions	Trip indicating	
	Stop	
	Test	
	Manual/Automatic Reset	
Setting range(A)		
Nominal current rating	Wire size	
	mm ²	AWG
42	10	8
55	16	6
65	25	4
74	25	4
80	35	3
93	35	2
107	50	1
113	50	1
130	50	0
130	70	00
153	95	000
200	120	250
265	185	350
350	240	500
515	185 × 2n	350 × 2n
660	240 × 2n	300 × 3n
Applied contactors		
Separate mounting unit		

150AF	
10A	20
MT-150/2H□(Q)	-
MT-150/3H□(Q)	-
MT-150/3K□(Q)	MT-150/3D□(Q)
Screw/Lug clamp	
3	
690V	
690V	
6kV	
IP 20	
-5~+40°C	
■	
■	
■	
■	
34~150A	34~150A
34~50	
45~65	
54~75	
63~85	
-	
80~105	
-	
95~130	
110~150	
MC-130a(Q), 150a(Q)	
UZ-150	

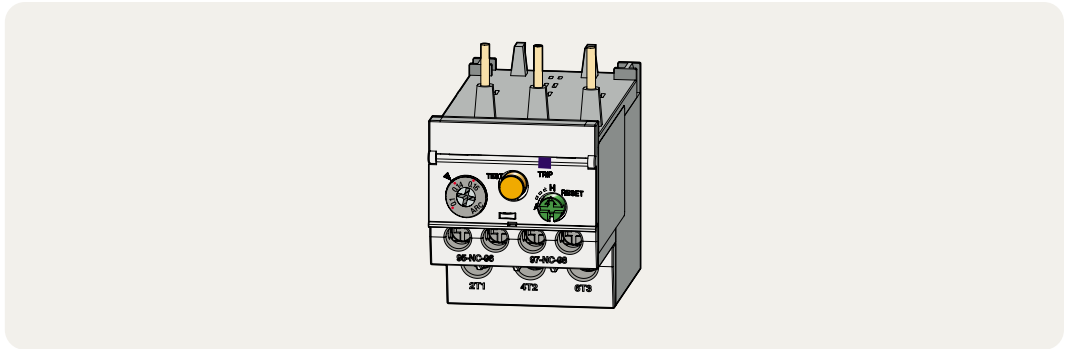
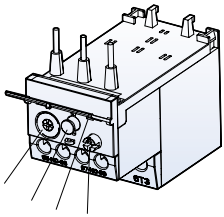

1. Adjustment dial



Before adjusting the dial open the protection cover.
Current setting can be done easily by using (+) or (-) driver.
Do not rotate the dial out of the setting range.

2. Stop/Test button

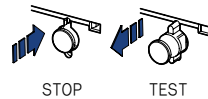

STOP function is executed by pushing the button, which causes the next sequence.
In case of operation test pull this button.

3. Trip indicator

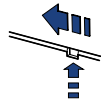

If relay is tripped it comes out.

4. Reset button/Selector

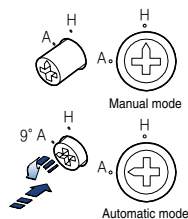

Using a driver the reset mode can be set.
In case of Manual mode(H) push the button to reset the relay.
To change to Automatic mode(A) from Manual mode push the button and rotate as shown in the fig.

5. Auxiliary contact operation

Terminal no.	Normal	STOP	TEST/TRIP	RESET
NC 95-96				
NO 97-98				

Separate mounting units

These accessories are used to mount the relays separately from contactors. If a relay is combined with a unit, it can be mounted on DIN rail or panel by fixing screws.



Relay	Unit	
	Type	Weight
MT-12/2H□(Q)	UZ-12	35g
MT-12/3H□(Q)		
MT-12/3K□(Q)		
MT-12/3D□(Q)		
MT-32/2H□(Q)	UZ-32	68g
MT-32/3H□(Q)		
MT-32/3K□(Q)		
MT-32/3D□(Q)		
MT-63/2H□(Q)	UZ-63	134g
MT-63/3H□(Q)		
MT-63/3K□(Q)		
MT-63/3D□(Q)		
MT-95/2H□(Q)	UZ-95	230g
MT-95/3H□(Q)		
MT-95/3K□(Q)		
MT-95/3D□(Q)		
MT-150/2H□(Q)	UZ-150	284g
MT-150/3H□(Q)		
MT-150/3K□(Q)		
MT-150/3D□(Q)		

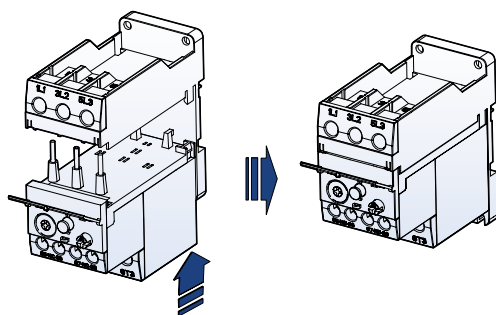

Terminal cover units for overload relays



Relay	Unit type	Remarks
MT-225(Q)	APT-225	2 pcs included
MT-400(Q)	APT-400	
MT-800(Q)	APT-600	

Remote reset units

These accessories are used to reset the relays on the panel door.



Type	Cable length (L)
UM-4R	400 mm
UM-5R	500 mm
UM-6R	600 mm

1. Make the reset bar straight at least 55mm from the panel door and 35mm from the bracket.
2. The bending radius of the flexible reset bar should not be less than 15mm.

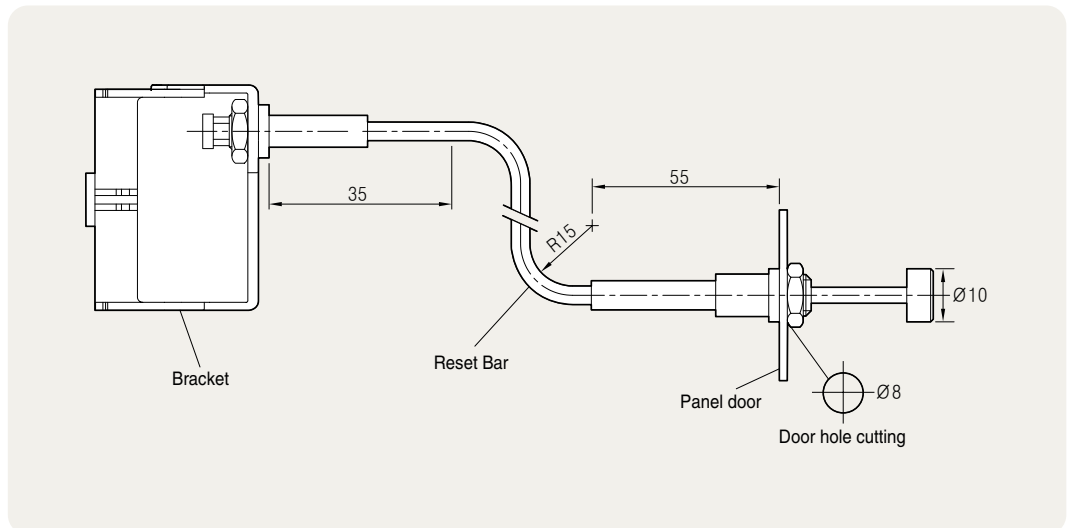

Installation

1. Fit the bracket with the relay as indicated(*1) below.
2. Separate Nut(*3) and Head cap(*4) from the reset bar first.
Insert the reset bar into the panel hole and then fix it with the Nut and Head.
3. To separate the bracket from the relay lift the *2 part as shown in the fig.

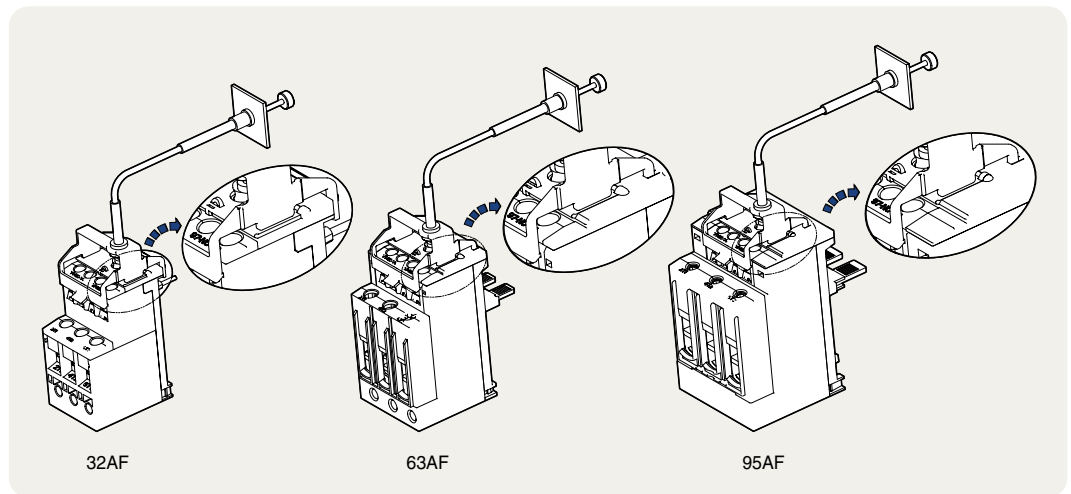

32AF

63AF

95AF

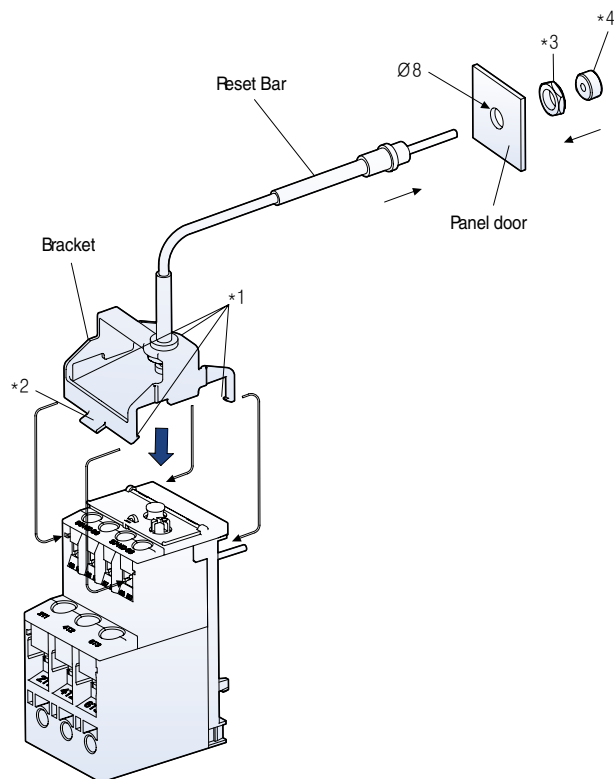

Trip class 10A

Terminal type: Screw

MT-12(Q)



MT-12/□(Q)

Setting range (A)	Ordering type			Contactor	Separate mounting unit
	Non-differential (3P-2 heater)	Non-differential (3P-3 heater)	Differential		
0.1~0.16	MT-12/2H0.14	MT-12/3H0.14	MT-12/3K0.14	MC-6a(Q) MC-9a(Q) MC-12a(Q) MC-18a(Q)	UZ-12
0.16~0.25	MT-12/2H0.21	MT-12/3H0.21	MT-12/3K0.21		
0.25~0.4	MT-12/2H0.33	MT-12/3H0.33	MT-12/3K0.33		
0.4~0.63	MT-12/2H0.52	MT-12/3H0.52	MT-12/3K0.52		
0.63~1	MT-12/2H0.82	MT-12/3H0.82	MT-12/3K0.82		
1~1.6	MT-12/2H1.3	MT-12/3H1.3	MT-12/3K1.3		
1.6~2.5	MT-12/2H2.1	MT-12/3H2.1	MT-12/3K2.1		
2.5~4	MT-12/2H3.3	MT-12/3H3.3	MT-12/3K3.3		
4~6	MT-12/2H5	MT-12/3H5	MT-12/3K5		
5~8	MT-12/2H6.5	MT-12/3H6.5	MT-12/3K6.5		
6~9	MT-12/2H7.5	MT-12/3H7.5	MT-12/3K7.5		
7~10	MT-12/2H8.5	MT-12/3H8.5	MT-12/3K8.5		
9~13	MT-12/2H11	MT-12/3H11	MT-12/3K11		
12~18	MT-12/2H15	MT-12/3H15	MT-12/3K15		

MT-32(Q)



MT-32/□(Q)

Setting range (A)	Ordering type			Contactor	Separate mounting unit		
	Non-differential (3P-2 heater)	Non-differential (3P-3 heater)	Differential				
0.1~0.16	MT-32/2H0.14	MT-32/3H0.14	MT-32/3K0.14	MC-9b(Q) MC-12b(Q) MC-18b(Q) MC-22b(Q) MC-32a(Q) MC-40a(Q)	UZ-32		
0.16~0.25	MT-32/2H0.21	MT-32/3H0.21	MT-32/3K0.21				
0.25~0.4	MT-32/2H0.33	MT-32/3H0.33	MT-32/3K0.33				
0.4~0.63	MT-32/2H0.52	MT-32/3H0.52	MT-32/3K0.52				
0.63~1	MT-32/2H0.82	MT-32/3H0.82	MT-32/3K0.82				
1~1.6	MT-32/2H1.3	MT-32/3H1.3	MT-32/3K1.3				
1.6~2.5	MT-32/2H2.1	MT-32/3H2.1	MT-32/3K2.1				
2.5~4	MT-32/2H3.3	MT-32/3H3.3	MT-32/3K3.3				
4~6	MT-32/2H5	MT-32/3H5	MT-32/3K5				
5~8	MT-32/2H6.5	MT-32/3H6.5	MT-32/3K6.5				
6~9	MT-32/2H7.5	MT-32/3H7.5	MT-32/3K7.5				
7~10	MT-32/2H8.5	MT-32/3H8.5	MT-32/3K8.5				
9~13	MT-32/2H11	MT-32/3H11	MT-32/3K11				
12~18	MT-32/2H15	MT-32/3H15	MT-32/3K15				
16~22	MT-32/2H19	MT-32/3H19	MT-32/3K19				
18~25	MT-32/2H21.5	MT-32/3H21.5	MT-32/3K21.5				
22~32	MT-32/2H27	MT-32/3H27	MT-32/3K27				
28~40	MT-32/2H34	MT-32/3H34	MT-32/3K34				
							UZ-32(34A)

Trip class 10A

Terminal type: Screw

MT-63(Q)



MT-63/□

Setting range (A)	Ordering type			Contactor	Separate mounting unit
	Non-differential (3P-2 heater)	Non-differential (3P-3 heater)	Differential		
4~6	MT-63/2H5	MT-63/3H5	MT-63/3K5	MC-50a(Q) MC-65a(Q)	UZ-63
5~8	MT-63/2H6.5	MT-63/3H6.5	MT-63/3K6.5		
6~9	MT-63/2H7.5	MT-63/3H7.5	MT-63/3K7.5		
7~10	MT-63/2H8.5	MT-63/3H8.5	MT-63/3K8.5		
9~13	MT-63/2H11	MT-63/3H11	MT-63/3K11		
12~18	MT-63/2H15	MT-63/3H15	MT-63/3K15		
16~22	MT-63/2H19	MT-63/3H19	MT-63/3K19		
18~25	MT-63/2H21.5	MT-63/3H21.5	MT-63/3K21.5		
24~36	MT-63/2H30	MT-63/3H30	MT-63/3K30		
28~40	MT-63/2H34	MT-63/3H34	MT-63/3K34		
34~50	MT-63/2H42	MT-63/3H42	MT-63/3K42		
45~65	MT-63/2H55	MT-63/3H55	MT-63/3K55		

MT-95(Q)



MT-95/□(Q)

Setting range (A)	Ordering type			Contactor	Separate mounting unit
	Non-differential (3P-2 heater)	Non-differential (3P-3 heater)	Differential		
7~10	MT-95/2H8.5	MT-95/3H8.5	MT-95/3K8.5	MC-75a(Q) MC-85a(Q) MC-100a(Q)	UZ-95
9~13	MT-95/2H11	MT-95/3H11	MT-95/3K11		
12~18	MT-95/2H15	MT-95/3H15	MT-95/3K15		
16~22	MT-95/2H19	MT-95/3H19	MT-95/3K19		
18~25	MT-95/2H21.5	MT-95/3H21.5	MT-95/3K21.5		
24~36	MT-95/2H30	MT-95/3H30	MT-95/3K30		
28~40	MT-95/2H34	MT-95/3H34	MT-95/3K34		
34~50	MT-95/2H42	MT-95/3H42	MT-95/3K42		
45~65	MT-95/2H55	MT-95/3H55	MT-95/3K55		
54~75	MT-95/2H65	MT-95/3H65	MT-95/3K65		
63~85	MT-95/2H74	MT-95/3H74	MT-95/3K74		
70~95	MT-95/2H83	MT-95/3H83	MT-95/3K83		
80~100	MT-95/2H90	MT-95/3H90	MT-95/3K90		

MT-150(Q)



MT-150/□(Q)

Setting range (A)	Ordering type			Contactor	Separate mounting unit
	Non-differential		Differential		
	(3P-2 heater)	(3P-3 heater)			
34~50	MT-150/2H42	MT-150/3H42	MT-150/3K42	MC-130a(Q) MC-150a(Q)	UZ-150
45~65	MT-150/2H55	MT-150/3H55	MT-150/3K55		
54~75	MT-150/2H65	MT-150/3H65	MT-150/3K65		
63~85	MT-150/2H74	MT-150/3H74	MT-150/3K74		
80~105	MT-150/2H93	MT-150/3H93	MT-150/3K93		
95~130	MT-150/2H113	MT-150/3H113	MT-150/3K113		
110~150	MT-150/2H130	MT-150/3H130	MT-150/3K130		

Trip class 10A

Terminal type: Screw

MT-225(Q)



MT-225/□(Q)

Setting range (A)	Ordering type			Contactor	Remarks
	Non-differential		Differential		
	(3P-2 heater)	(3P-3 heater)			
65~100	MT-225/2H80	MT-225/3H80	MT-225/3K80	MC-185a(Q) MC-225a(Q)	-
85~125	MT-225/2H107	MT-225/3H107	MT-225/3K107		
100~160	MT-225/2H130	MT-225/3H130	MT-225/3K130		
120~185	MT-225/2H153	MT-225/3H153	MT-225/3K153		
160~240	MT-225/2H200	MT-225/3H200	MT-225/3K200		

MT-400(Q)



MT-400/□(Q)

Setting range (A)	Ordering type			Contactor	Remarks
	Non-differential		Differential		
	(3P-2 heater)	(3P-3 heater)			
85~125	MT-400/2H107	MT-400/3H107	MT-400/3K107	MC-265a(Q) MC-330a(Q) MC-400a(Q)	-
100~160	MT-400/2H130	MT-400/3H130	MT-400/3K130		
120~185	MT-400/2H153	MT-400/3H153	MT-400/3K153		
160~240	MT-400/2H200	MT-400/3H200	MT-400/3K200		
200~330	MT-400/2H265	MT-400/3H265	MT-400/3K265		
260~400	MT-400/2H350	MT-400/3H350	MT-400/3K350		

MT-800(Q)



MT-800/□(Q)

Setting range (A)	Ordering type			Contactor	Remarks
	Non-differential		Differential		
	(3P-2 heater)	(3P-3 heater)			
200~330	MT-800/2H265	MT-800/3H265	MT-800/3K265	MC-500a(Q) MC-630a(Q) MC-800a(Q)	-
260~400	MT-800/2H350	MT-800/3H350	MT-800/3K350		
400~630	MT-800/2H515	MT-800/3H515	MT-800/3K515		
520~800	MT-800/2H660	MT-800/3H660	MT-800/3K660		

Trip class 20

Terminal type: Screw

MT-12(Q)



MT-12/3D□(Q)

Setting range (A)	Ordering type	Contactor	Separate mounting unit
	Differential		
1~1.6	MT-12/3D1.3	MC-6a(Q) MC-9a(Q) MC-12a(Q) MC-18a(Q)	UZ-12
1.6~2.5	MT-12/3D2.1		
2.5~4	MT-12/3D3.3		
4~6	MT-12/3D5		
5~8	MT-12/3D6.5		
6~9	MT-12/3D7.5		
7~10	MT-12/3D8.5		
9~13	MT-12/3D11		
12~18	MT-12/3D15		

MT-32(Q)



MT-32/3D□(Q)

Setting range (A)	Ordering type	Contactor	Separate mounting unit	
	Differential			
1~1.6	MT-32/3D1.3	MC-9b(Q) MC-12b(Q) MC-18b(Q) MC-22b(Q) MC-32a(Q) MC-40a(Q)	UZ-32	
1.6~2.5	MT-32/3D2.1			
2.5~4	MT-32/3D3.3			
4~6	MT-32/3D5			
5~8	MT-32/3D6.5			
6~9	MT-32/3D7.5			
7~10	MT-32/3D8.5			
9~13	MT-32/3D11			
12~18	MT-32/3D15			
16~22	MT-32/3D19			
18~25	MT-32/3D21.5			
22~32	MT-32/3D27			
28~40	MT-32/3D34			UZ-32(34A)

Trip class 20

Terminal type: Screw

MT-63(Q)



MT-63/□(Q)

Setting range (A)	Ordering type	Contactor	Separate mounting unit
	Differential		
4~6	MT-63/3D5	MC-50a(Q) MC-65a(Q)	UZ-63
5~8	MT-63/3D6.5		
6~9	MT-63/3D7.5		
7~10	MT-63/3D8.5		
9~13	MT-63/3D11		
12~18	MT-63/3D15		
16~22	MT-63/3D19		
18~25	MT-63/3D21.5		
24~36	MT-63/3D30		
28~40	MT-63/3D34		
34~50	MT-63/3D42		
45~65	MT-63/3D55		

MT-95(Q)



MT-95/□(Q)

Setting range (A)	Ordering type	Contactor	Separate mounting unit
	Differential		
7~10	MT-95/3D8.5	MC-75a(Q) MC-85a(Q) MC-100a(Q)	UZ-95
9~13	MT-95/3D11		
12~18	MT-95/3DK15		
16~22	MT-95/3D19		
18~25	MT-95/3D21.5		
24~36	MT-95/3D30		
28~40	MT-95/3D34		
34~50	MT-95/3D42		
45~65	MT-95/3D55		
54~75	MT-95/3D65		
63~85	MT-95/3D74		
70~95	MT-95/3D83		
80~100	MT-95/3D90		

MT-150(Q)



MT-150/□(Q)

Setting range (A)	Ordering type	Contactor	Separate mounting unit
	Differential		
34~50	MT-150/3D42	MC-130a(Q) MC-150a(Q)	UZ-150
45~65	MT-150/3D55		
54~75	MT-150/3D65		
63~85	MT-150/3D74		
80~105	MT-150/3D93		
95~130	MT-150/3D113		
110~150	MT-150/3D130		

Trip class 20

Terminal type: Screw

MT-225(Q)



MT-225/3D□(Q)

Setting range (A)	Ordering type	Contactor	Remarks
	Differential		
65~100	MT-225/3D80	MC-185a(Q) MC-225a(Q)	-
85~125	MT-225/3D107		
100~160	MT-225/3D130		
120~185	MT-225/3D153		
160~240	MT-225/3D200		

MT-400(Q)



MT-400/3D□(Q)

Setting range (A)	Ordering type	Contactor	Remarks
	Differential		
85~125	MT-400/3D107	MC-265a(Q) MC-330a(Q) MC-400a(Q)	-
100~160	MT-400/3D130		
120~185	MT-400/3D153		
160~240	MT-400/3D200		
200~330	MT-400/3D265		
260~400	MT-400/3D350		

MT-800(Q)



MT-800/3D□(Q)

Setting range (A)	Ordering type	Contactor	Remarks
	Differential		
200~330	MT-800/3D265	MC-500a(Q) MC-630a(Q) MC-800a(Q)	-
260~400	MT-800/3D350		
400~630	MT-800/3D515		
520~800	MT-800/3D660		

Class 10A

- MT-12/2H
- MT-12/3H
- MT-12/3K

Cold starting

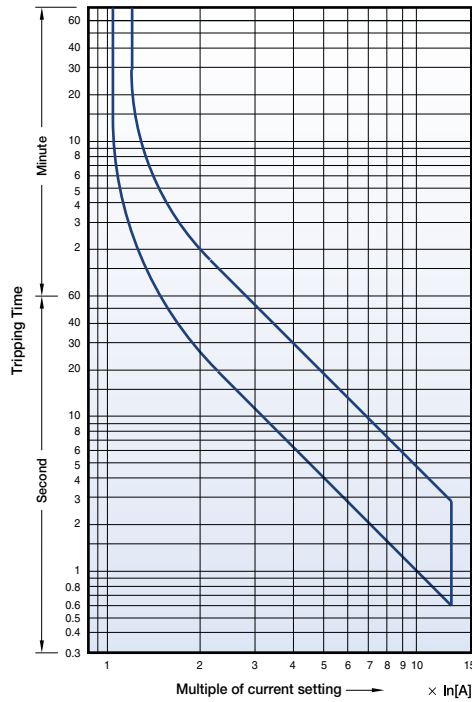

Hot starting

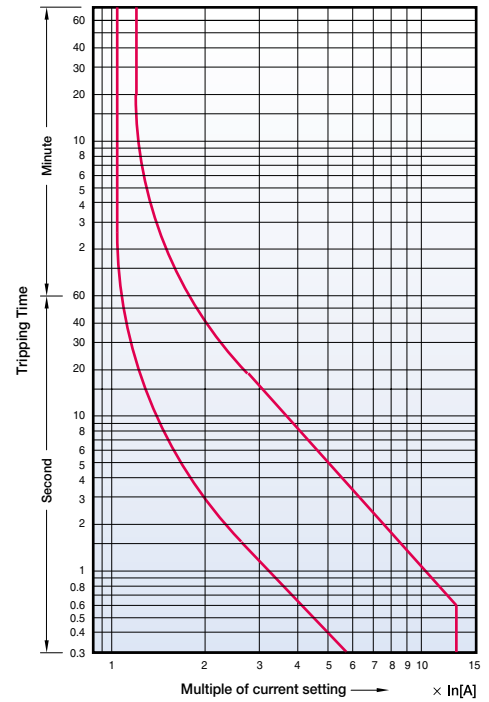

Cold starting

- MT-32/2H
- MT-32/3H
- MT-32/3K

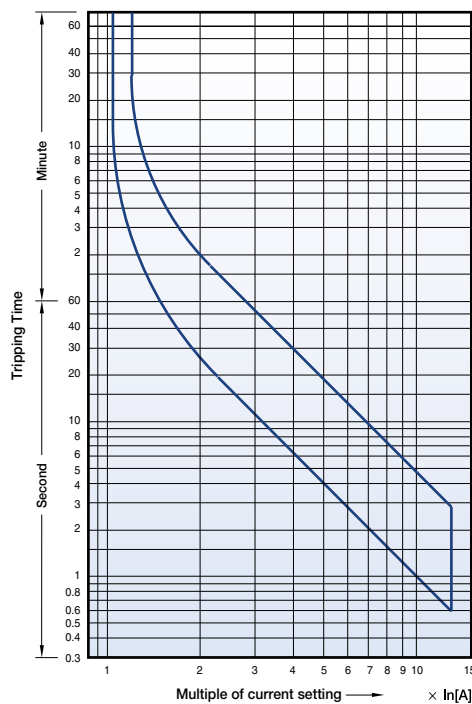

Hot starting

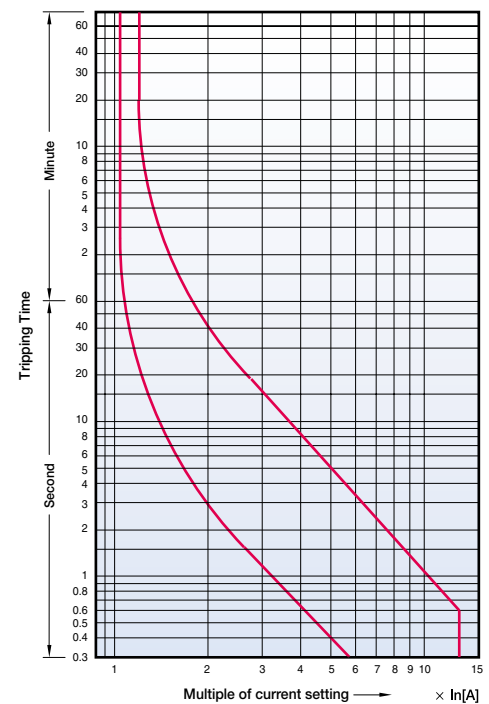

Class 10A

- MT-63/2H
- MT-63/3H
- MT-63/3K

Cold starting

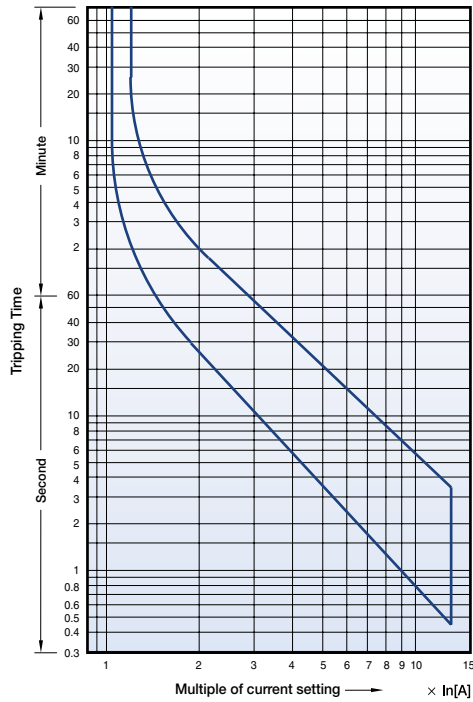

Hot starting

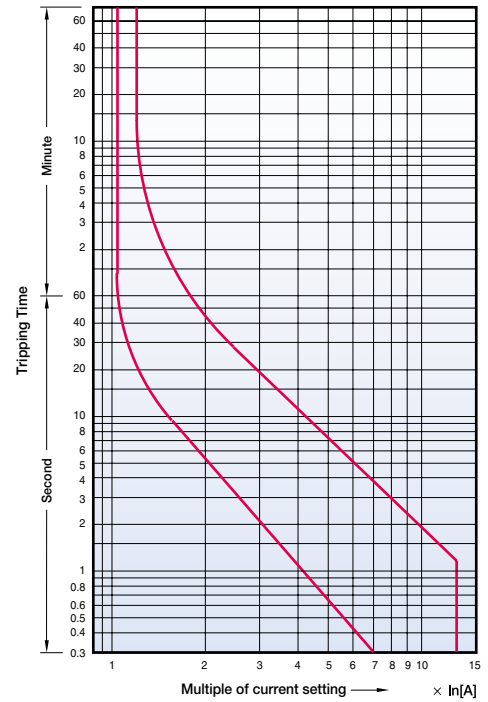

Cold starting

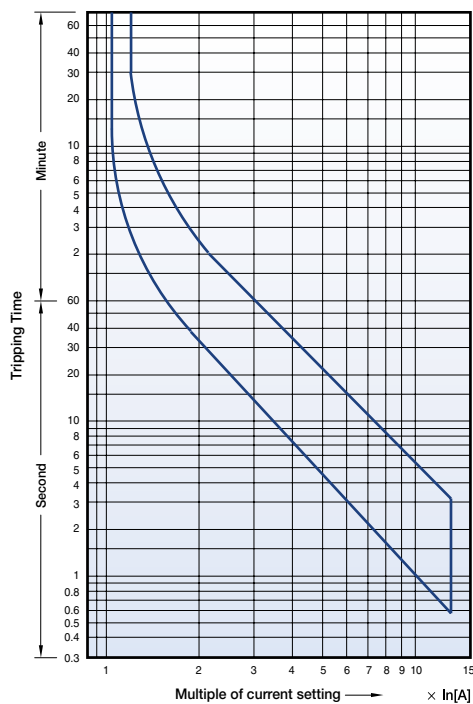

Hot starting

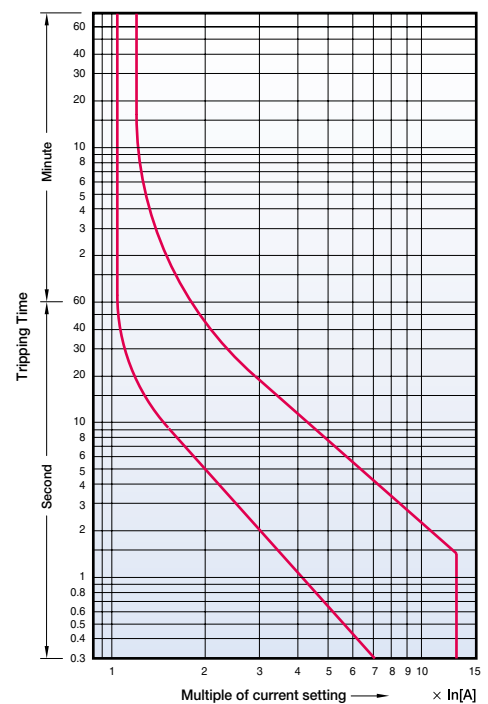

- MT-150/2H
- MT-150/3H
- MT-150/3K

Class 10A

MT-225/2H

MT-225/3H

MT-225/3K

Cold starting

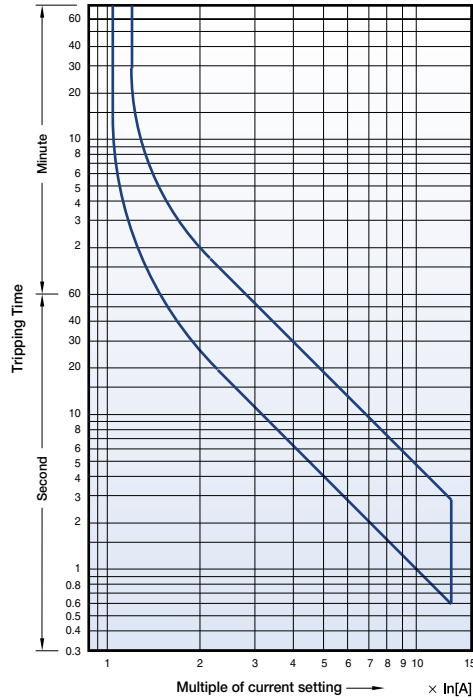

Hot starting

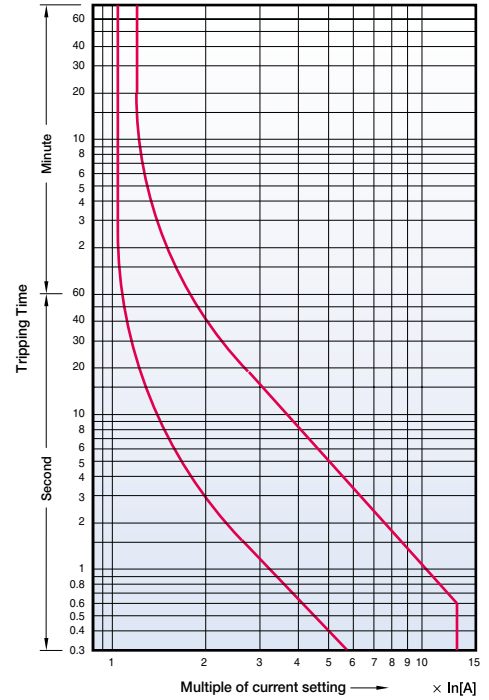

Cold starting

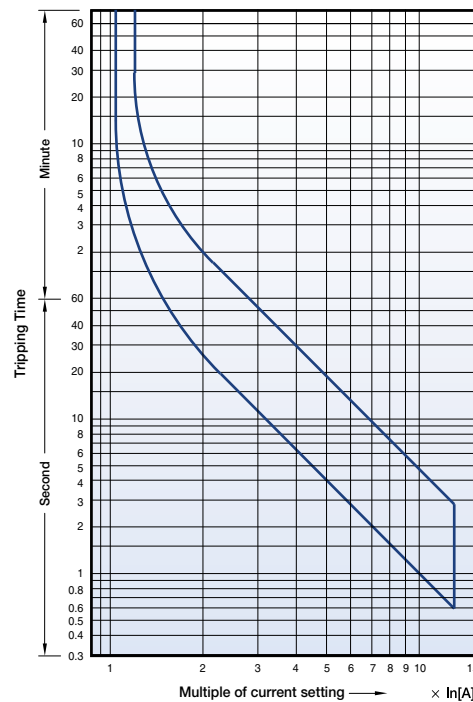

Hot starting

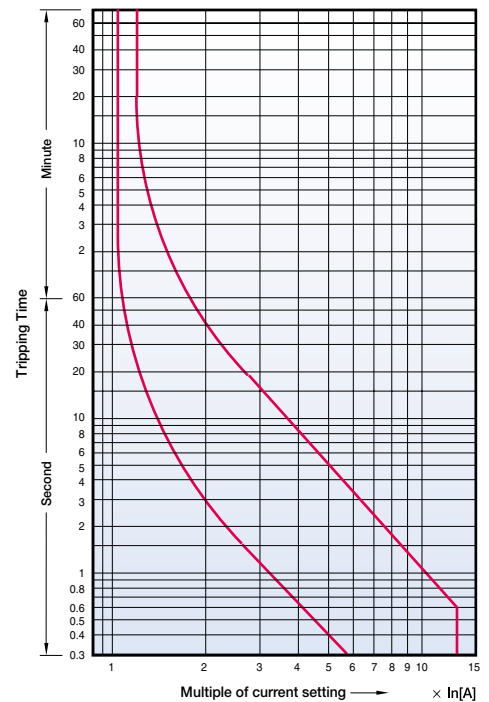

Class 10A

- MT-800/2H
- MT-800/3H
- MT-800/3K

Cold starting

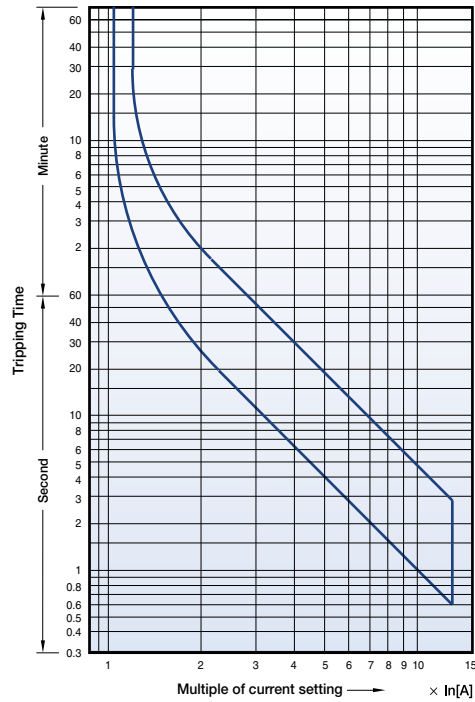

Hot starting

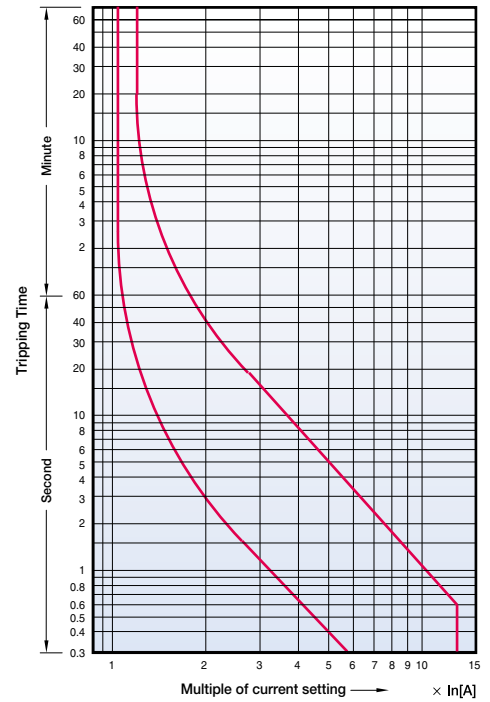

3-pole contactors dimension (18AF/22AF)

For Nuclear power plant

Metasol

MC-6a(Q) ~ 18a(Q) AC
1NO or 1NC

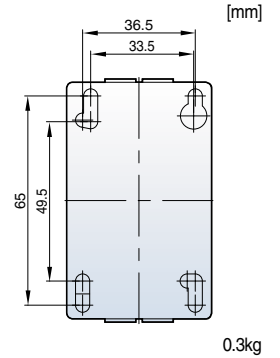
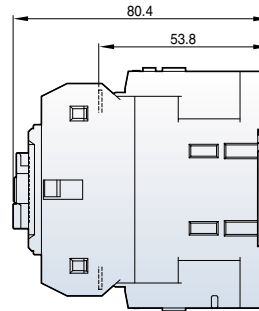
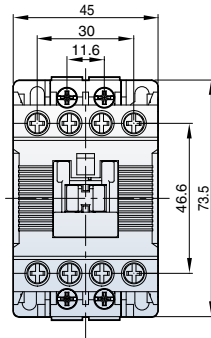

MC-6a(Q) ~ 18a(Q) DC
1NO or 1NC

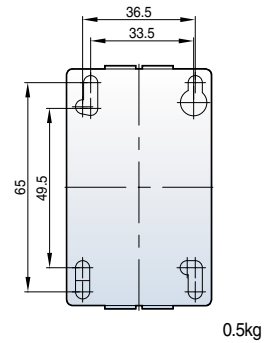
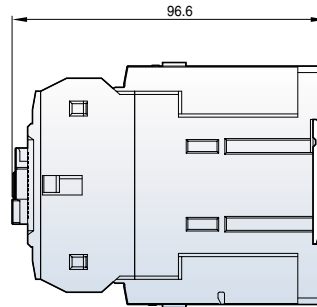
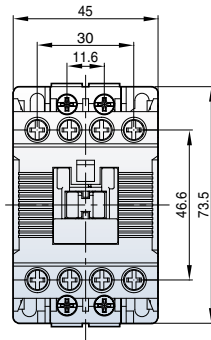

MC-9b(Q) ~ 22b(Q) AC
1NO1NC

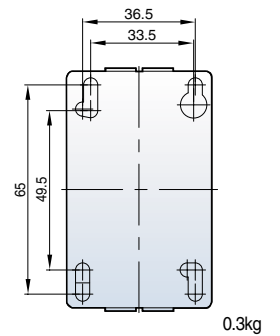
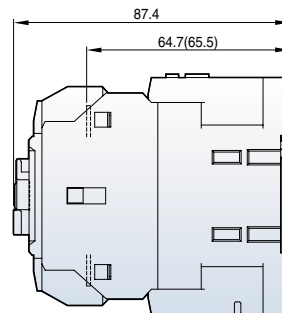
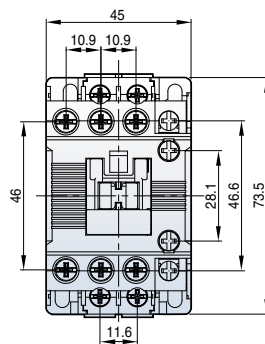

* () MC-18b, 22b

MC-9b(Q) ~ 22b(Q) DC
1NO1NC

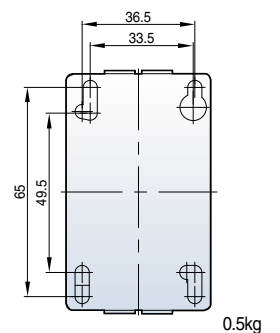
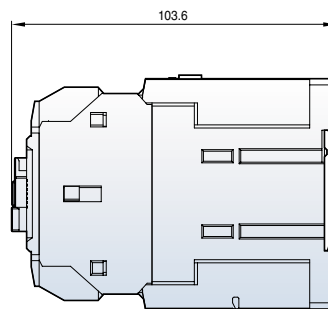
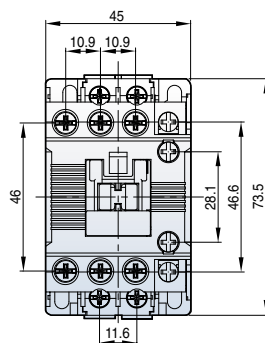

3-pole contactors dimension (40AF)

For Nuclear power plant

Metasol

MC-32a(Q) ~ 40a(Q) AC

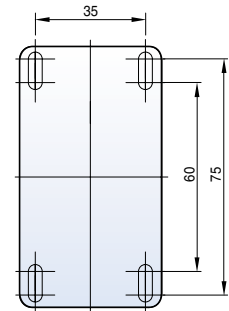
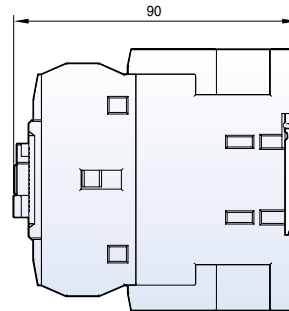
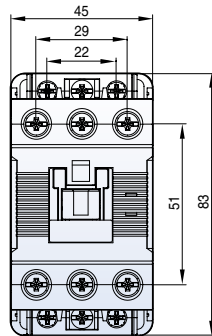

[mm]

0.4kg

MC-32a(Q) ~ 40a(Q) DC

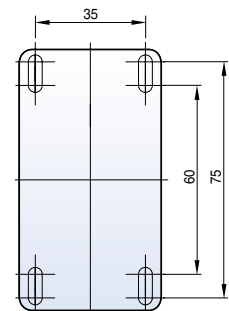
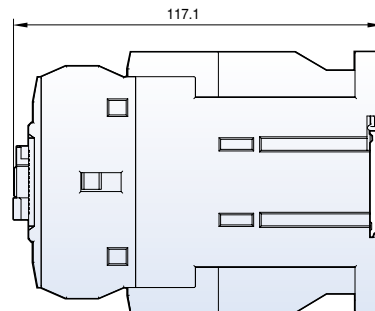
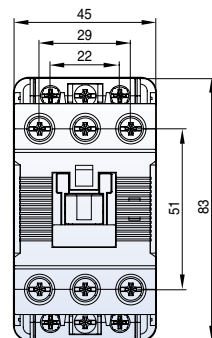

0.6kg

MC-32a(Q) ~ 40a(Q) AC
2NO2NC

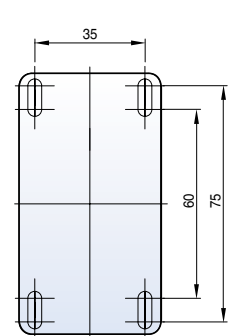
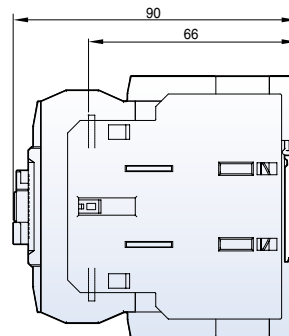
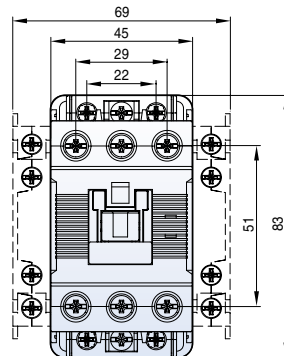

0.5kg

MC-32a(Q) ~ 40a(Q) DC
2NO2NC

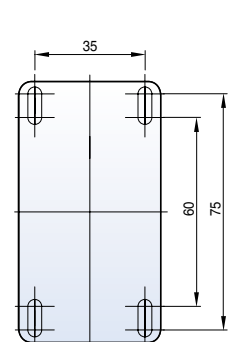
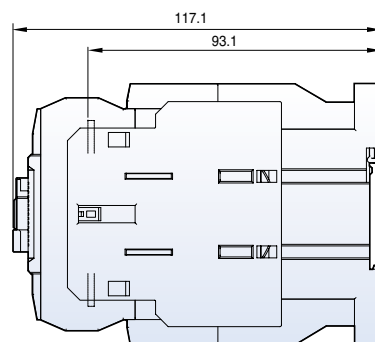
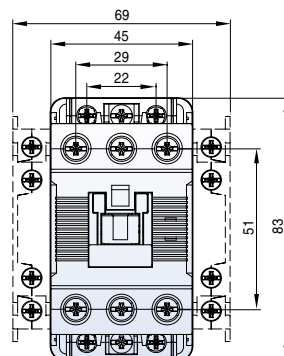

0.8kg

3-pole contactors dimension (65AF)

For Nuclear power plant

Metasol

MC-50a(Q) ~ 65a(Q) AC

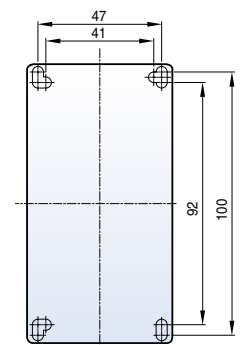
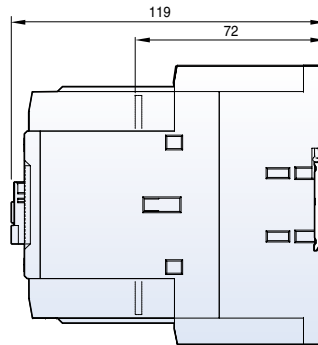
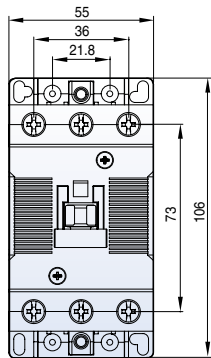

[mm]

0.9kg

MC-50a(Q) ~ 65a(Q) DC

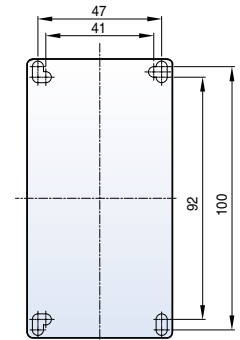
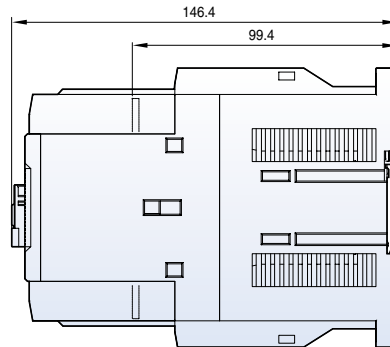
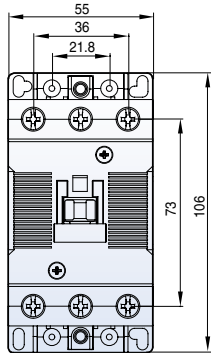

1.2kg

MC-50a(Q) ~ 65a(Q) AC
2NO2NC

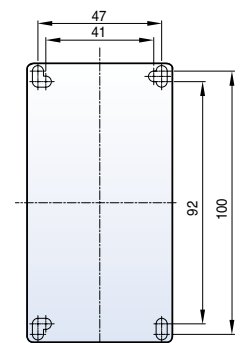
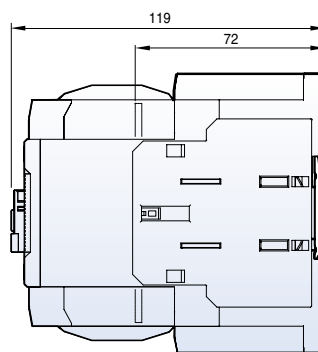
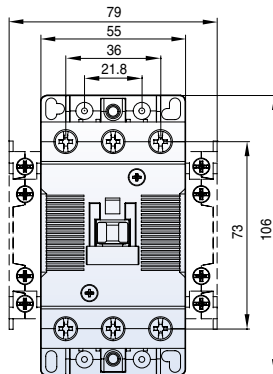

1kg

MC-50a(Q) ~ 65a(Q) DC
2NO2NC

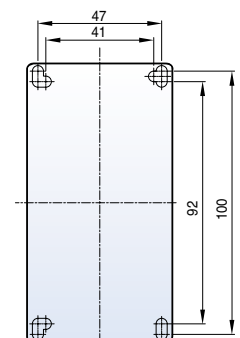
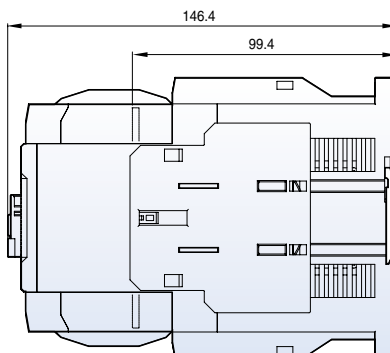
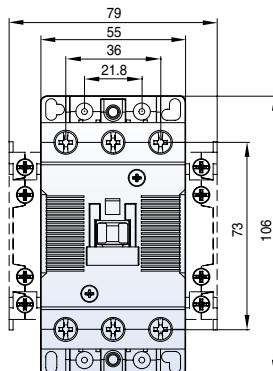

1.3kg

3-pole contactors dimension (100AF)

For Nuclear power plant

Metasol

MC-75a(Q) - 100a(Q) AC

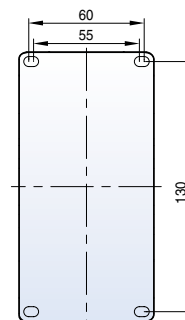
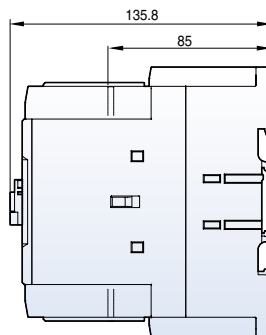
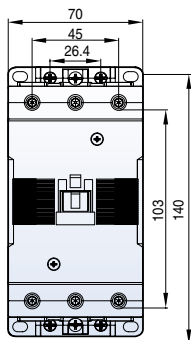

[mm]

1.8kg

MC-75a(Q) - 100a(Q) DC

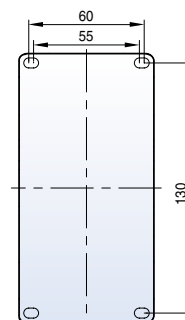
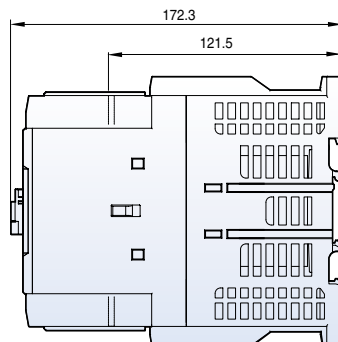
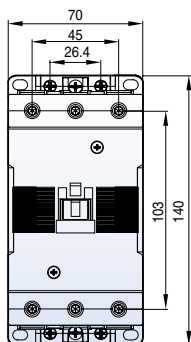

2.7kg

MC-75a(Q) - 100a(Q) AC
2NO2NC

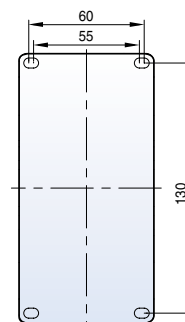
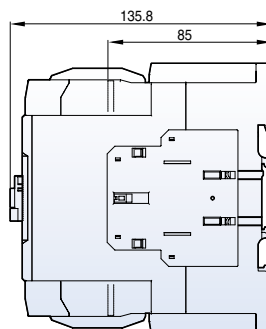
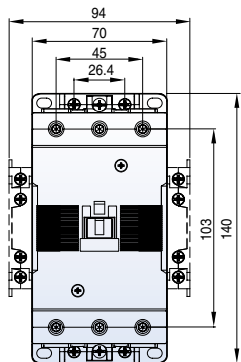

1.9kg

MC-75a(Q) - 100a(Q) DC
2NO2NC

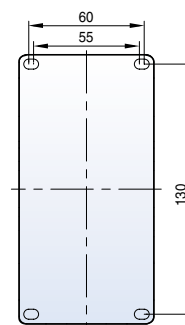
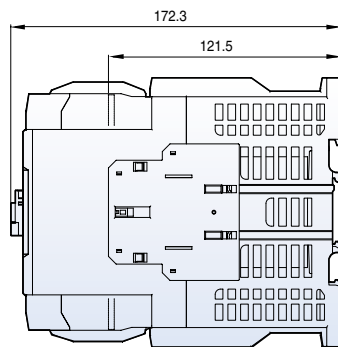
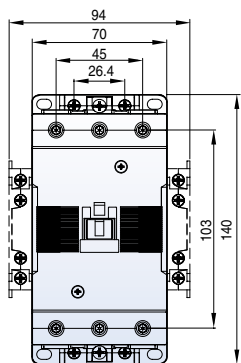

2.8kg

3-pole contactors dimension (150AF~800AF)

For Nuclear power plant

Metasol

MC-130a(Q)

MC-150a(Q)

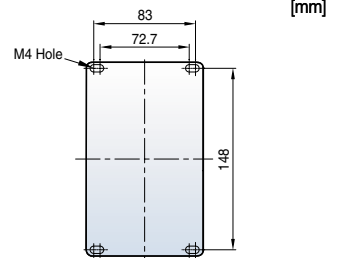
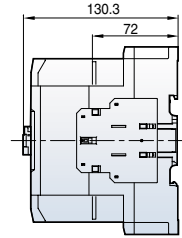
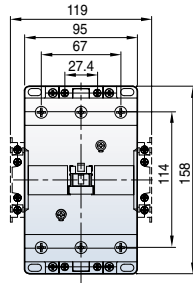

2.4kg

MC-185a(Q)

MC-225a(Q)

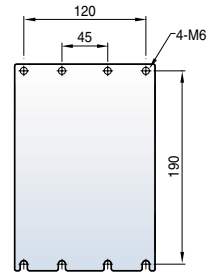
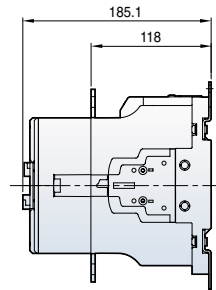
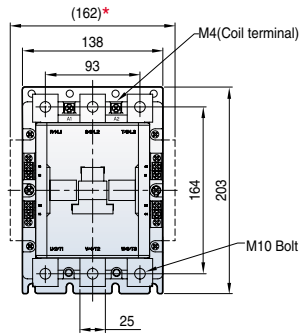

5.4kg

MC-265a(Q)

MC-330a(Q)

MC-400a(Q)

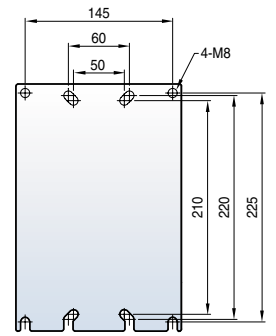
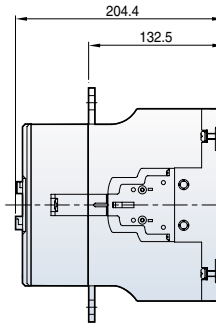
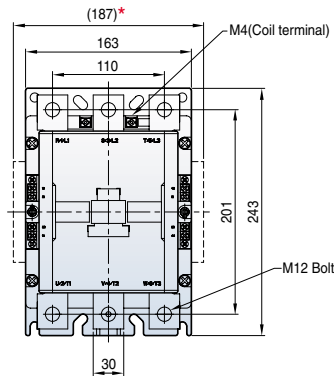

9.2kg

MC-500a(Q)

MC-630a(Q)

MC-800a(Q)

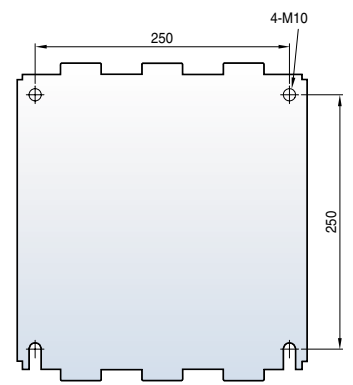
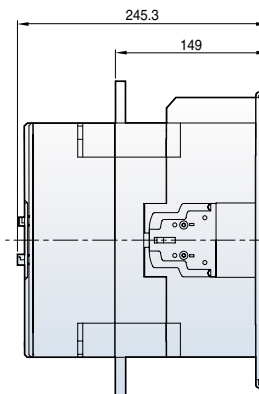
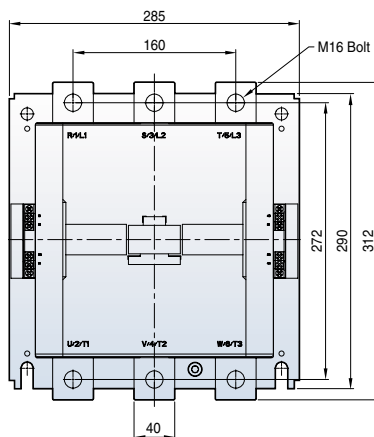

22.4kg

* Optional auxiliary contact unit (side mount type)

Overload relays dimension

For Nuclear power plant

Metasol

MT-12(Q)

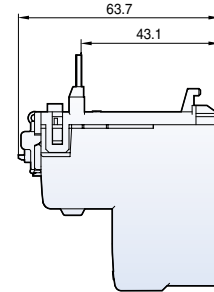
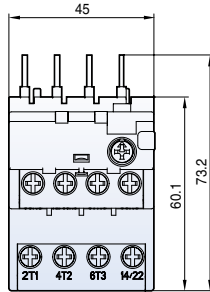

[mm]

100g

MT-32(Q)

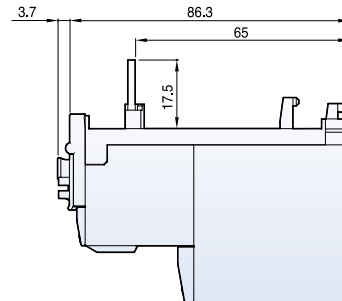
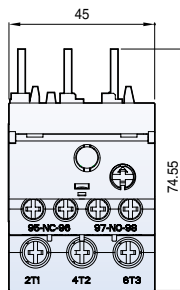

167g

MT-63(Q)

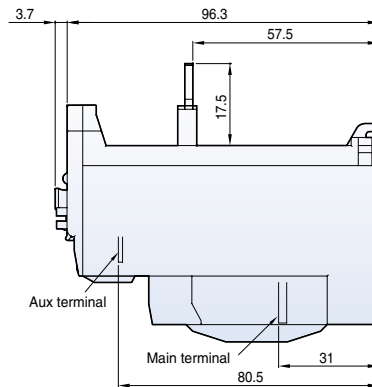
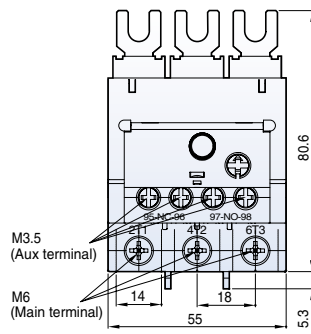

303g

MT-95(Q)

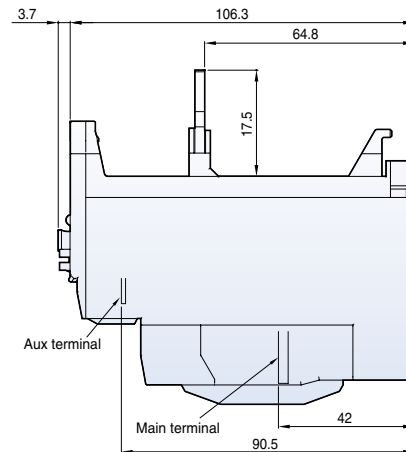
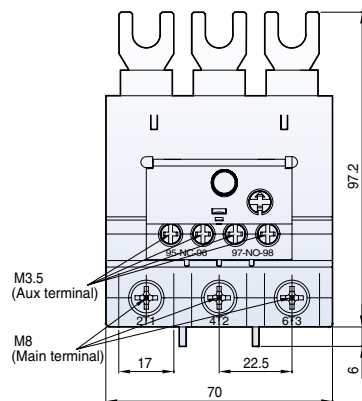

474g

Overload relays dimension

For Nuclear power plant

Metasol

MT-150(Q)

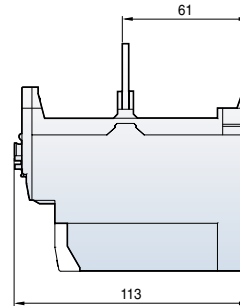
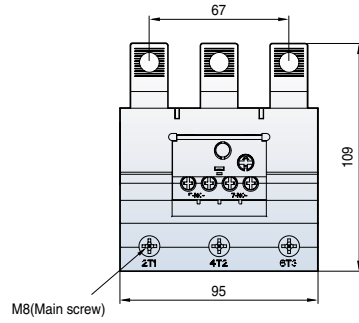

[mm]

0.7kg

MT-225(Q)

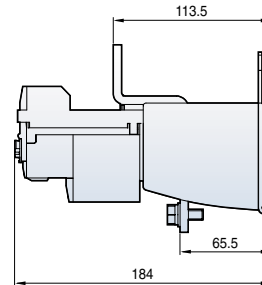
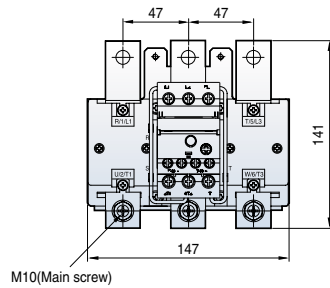

2.5kg

MT-400(Q)

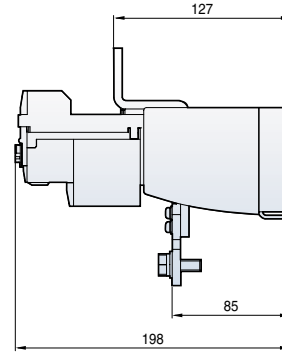
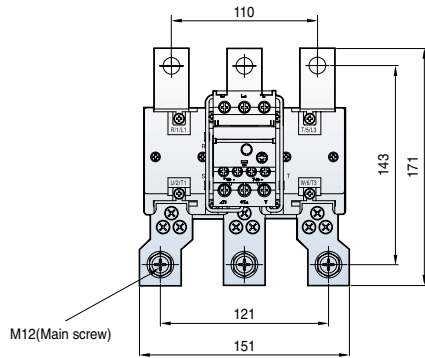

2.6kg

MT-800(Q)

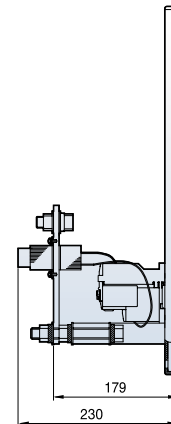
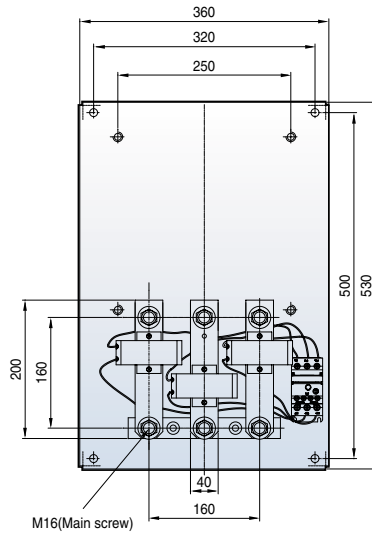

11.5kg

Overload relays dimension (Separate mount)

For Nuclear power plant

Metasol

UZ-12

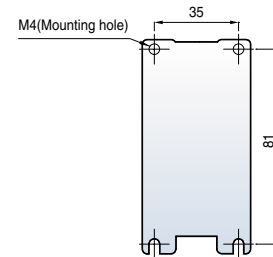
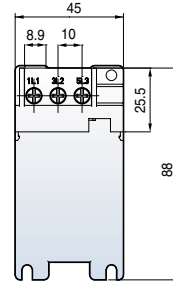
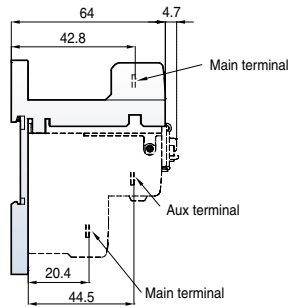

[mm]

35g

UZ-32

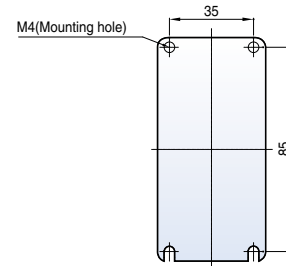
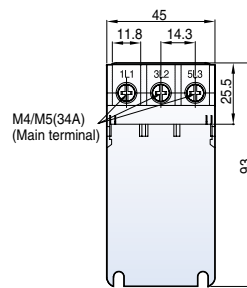
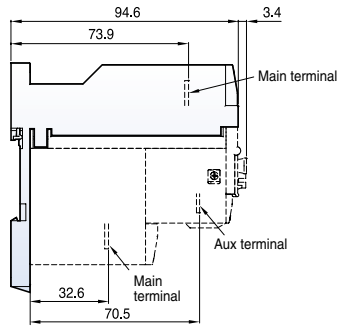

68g

UZ-63

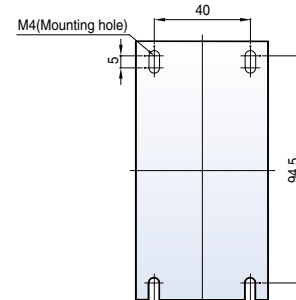
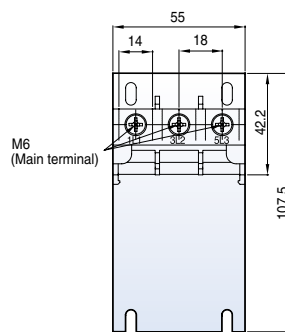
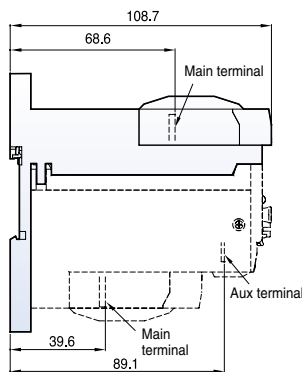

134g

Overload relays dimension (Separate mount)

For Nuclear power plant

Metasol

UZ-95

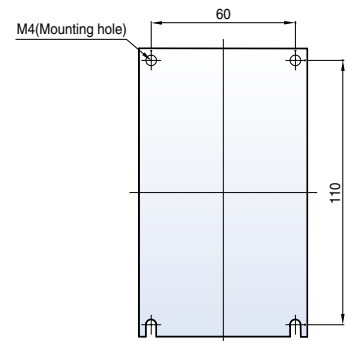
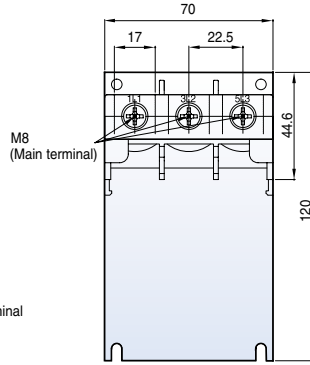
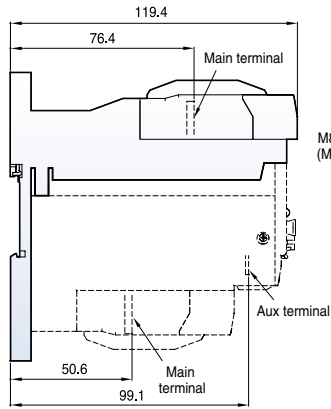

[mm]

230g

UZ-150

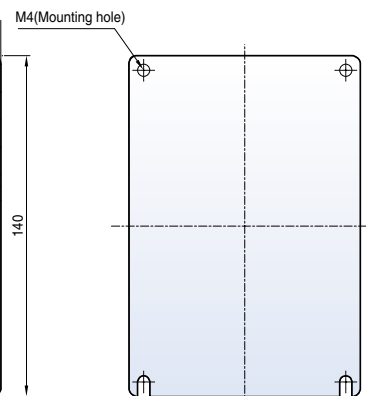
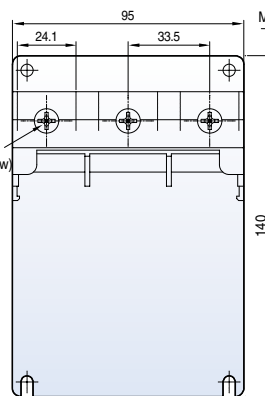
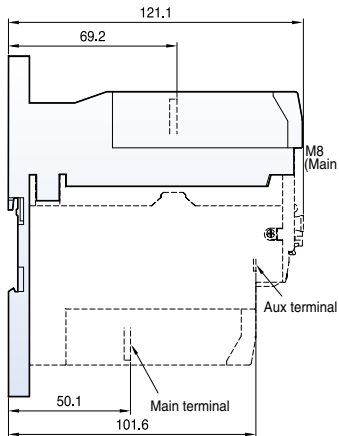

284g

Memo

LSMS



<Android>



<IOS>

This application is selection guide of motor starter, overload relays and MCCBs

Green Innovators of Innovation



Safety Instructions

- For your safety, please read user's manual thoroughly before operating.
- Contact the nearest authorized service facility for examination, repair, or adjustment.
- Please contact a qualified service technician when you need maintenance. Do not disassemble or repair by yourself!
- Any maintenance and inspection shall be performed by the personnel having expertise concerned.

LSIS Co., Ltd.

© 2013.07 LSIS Co.,Ltd. All rights reserved.

www.lsis.biz

■ HEAD OFFICE

LS-ro 127 (Hogye-dong) dongan-gu Anyang-si
Gyeonggi-do Korea
Tel. (82-2)2034-4887, 4873, 4918, 4148
Fax. (82-2)2034-4648

■ CHEONG-JU PLANT

Cheong-Ju Plant #1, Song Jung Dong, Hung Duk Ku,
Cheong Ju, 361-720, Korea

■ Global Network

- **LSIS (Middle East) FZE >> Dubai, U.A.E.**
Address: LOB 19 JAFZA VIEW TOWER Room 205, Jebel Ali Freezone P.O. Box 114216, Dubai, United Arab Emirates
Tel: 971-4-886 5360 Fax: 971-4-886-5361 e-mail: dhleef@lsis.biz
- **Dalian LSIS Co., Ltd. >> Dalian, China**
Address: No.15, Liaohexi 3-Road, Economic and Technical Development zone, Dalian 116600, China
Tel: 86-411-8273-7777 Fax: 86-411-8730-7560 e-mail: tangyh@lsis.com.cn
- **LSIS (Wuxi) Co., Ltd. >> Wuxi, China**
Address: 102-A, National High & New Tech Industrial Development Area, Wuxi, Jiangsu, 214028, P.R.China
Tel: 86-510-8534-6666 Fax: 86-510-522-4078 e-mail: luw@lsis.com.cn
- **LSIS-VINA Co., Ltd. >> Hanoi, Vietnam**
Address: Nguyen Khe - Dong Anh - Ha Noi - Viet Nam
Tel: 84-4-882-0222 Fax: 84-4-882-0220 e-mail: sjbaik@lsis.biz
- **LSIS-VINA Co., Ltd. >> Hochiminh, Vietnam**
Address: 41 Nguyen Thi Minh Khai Str. Yoco Bldg 4th Floor, Hochiminh City, Vietnam
Tel: 84-8-3822-7941 Fax: 84-8-3822-7942 e-mail: hjchoid@lsis.biz
- **LSIS Shanghai Office >> Shanghai, China**
Address: Room 32 floors of the Great Wall Building, No. 3000 North Zhongshan Road, Putuo District, Shanghai, China
Tel: 86-21-5237-9977 Fax: 89-21-5237-7189 e-mail: baijh@lsis.com.cn
- **LSIS Beijing Office >> Beijing, China**
Address: B-Tower 17FL.Beijing Global Trade Center B/D. No.36, BeiSanHuanDong-Lu, DongCheng-District, Beijing 100013, P.R. China
Tel: 86-10-5825-6025,7 Fax: 86-10-5825-6026 e-mail: sunmj@lsis.com.cn
- **LSIS Guangzhou Office >> Guangzhou, China**
Address: Room 1403, 14/F, New Poly Tower, No.2 Zhongshan Liu Road, Guangzhou 510180, P.R. China
Tel: 020-8326-6754 Fax: 020-8326-6287 e-mail: chenxs@lsis.com.cn
- **LSIS Chengdu Office >> Chengdu, China**
Address: Room 1701 17Floor, huamin hanjun international Building, No1 Fuxing Road Chengdu, 610016, P.R. China
Tel: 86-28-8670-3201 Fax: 86-28-8670-3203 e-mail: yangcf@lsis.com.cn
- **LSIS Qingdao Office >> Qingdao, China**
Address: Room 2001,20/F,7B40, Galaxy Building, No.29 Shandong Road, Shinan District, Qingdao 266071, P.R. China
Tel: 86-532-8501-6058 Fax: 86-532-8501-6057 e-mail: wangzy@lsis.com.cn
- **LSIS NETHERLANDS Co.Ltd >> Schiphol-Rijk, Netherlands**
Address: 1st. Floor, Tupolevlaan 48, 1119NZ, Schiphol-Rijk, The Netherlands
Tel: 31-20-654-1420 Fax: 31-20-654-1429 e-mail: junshickp@lsis.biz
- **LSIS Gurgaon Office >> Gurgaon, India**
Address: 109 First Floor, Park Central, Sector-30, Gurgaon- 122 002, Haryana, India e-mail: hwyim@lsis.biz

Specifications in this catalog are subject to change without notice due to continuous product development and improvement.